



ENGINEERED *Excellence*™

Monitor Your Asset's Performance



Wherever It May Be!



Designed and
Manufactured
in the USA



www.FariaBeede.com

Is size an issue?

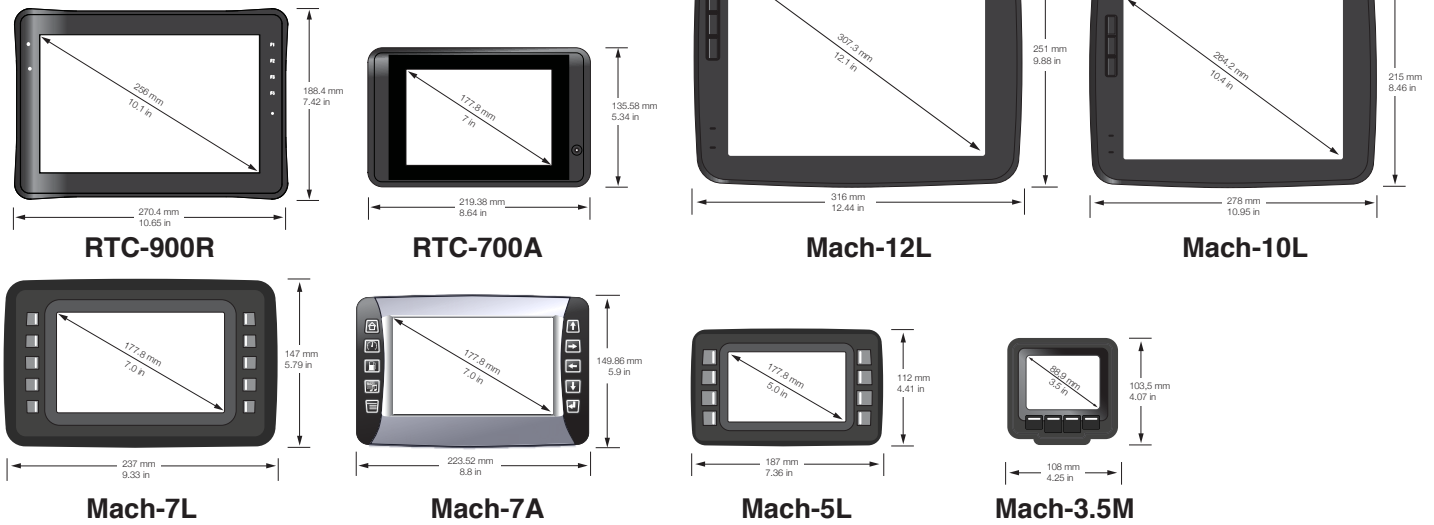

We've got the screen product to fit your needs.

Mach-3.5M

Full color instrumentation display

An easily configurable, full-color 3 1/2" display enabling appealing user interfaces in a compact form factor.

Designed especially for the off-highway and industrial markets, Mach-3.5M offers exceptional readability and all-weather performance. It is suitable for both bracket mounting and integration in a dashboard. With the QuiC™ software configuration tool you can rapidly program the Mach-3.5M without having specific software skills.

DISPLAY	3.5" QVGA, 320 x 240, 24 bit color depth, 400 cd/m ² (Minimum) TFT with LED backlight
INTERFACES	
- CAN	2 x CAN Spec 2.0B Protocols include J1939 and CAN open
USB	1 x USB 2.0 in Deutsch connector
- AUDIO	Buzzer for sound notification
- OUTPUTS	(2) High-current, 1.25A, high-side switched outputs
POWER SUPPLY	12 or 24 VDC nominal voltage with Reverse polarity, transients including load-dump, over-voltage, and ESD

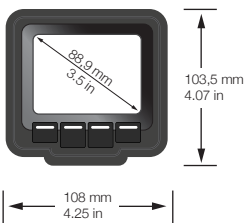

32 bits ARM processor, with 8-32 MB DDR RAM (Scalable)
16-128 MB NAND Flash memory for Data (Scalable)

TFT direct sunlight readable.
LED back-lighted display

Housing - Nylon, ABS-PC
4 soft keys with LED illumination and tactile feedback
Buzzer - for sound notifications

Weight: 0.2 kg (0.45 lb)

Environmental Specifications

- EMC Conformity: ISO 13766
- IP66 ingress protection
- Voltage: 12 or 24 V
9 - 32 VDC operating range
- Temperature range:
-40°C to +70°C
(-40°C to +80°C storage)

MQX



RAM mountable



Mach-5L

Freely programmable, multifunctional display

A 5.0" full-color display with a powerful ARM CPU. The open software platform has a choice of tools for design of premium graphical user interfaces. This, together with WVGA display resolution and high brightness display, enables fast design of sharp interfaces with high usability.

With touch screen and configurable soft keys, operators are offered a user friendly interaction with the system. Mach-5L has multifunctional capability and can be used as instrumentation display, control system GUI, video monitor, Service tool and more.

DISPLAY	
TYPE	TFT with LED backlight and anti-glare coated glass
SIZE AND RESOLUTION	5" WVGA, 800 x 480 pixels
COLOR DEPTH	24 bit
BRIGHTNESS	650 Cd/m ²
DIMMING	Automatic dimming through ambient light sensor. Dimming can be controlled manually via soft keys and/or touch screen
OPTICAL BONDING	TFT and glass optically bonded. Optical bonding is optional.
HMI	
TOUCH SCREEN	Type: Resistive. Touch screen is optional.
SOFT KEYS	8 soft keys, configurable. Soft keys can be used as function keys for the GUI, to control Power On/Off, to control display brightness etc. Soft keys are optional.
BUZZER	For alarms and notifications
INTERFACES	
CAN	2 x CAN. ISO11898 2.0B, bitrate configurable 20 – 250 kbps.
ETHERNET	1 x Ethernet. 10/100 Base-T.
USB	2 x USB 2.0. 1 in Deutsch connector and 1 mini-USB under cover on rear side for software upgrading.
VIDEO	1 x Analog Video input. NTSC or PAL.
KEY SWITCH	1 x Key switch input, for start-up/shut down
INPUTS	2 configurable inputs for analog/digital sensors. May be used for measuring resistance/4-20mA/frequency/digital/analog signals.
OUTPUTS	2 configurable high side outputs for driving up to 1A. May be used for continuous driver or PWM output.
POWER SUPPLY	12 or 24 VDC nominal voltage

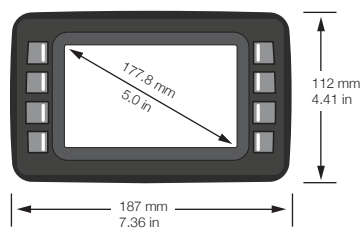

32 bits ARM processor, with 256 MB DDR3 RAM (Scalable)
512 MB NAND Flash memory for Data (Scalable)

TFT display with anti-glare coated glass and Automatic Dimming.
LED back-lighted display
(Optional touch screen)

Housing - Plastic
8 application controlled soft-buttons
Buzzer - for sound notifications

Weight: 0.425 kg (0.94 lb)

Environmental Specifications

- EMC Conformity: 2004/108/EC, EN61000-6-2:2005,
- IP66 ingress protection
- Operating supply voltage range: 12 or 24 V
- Operating temperature range: -40 to +70°C
(-40°C +85°C storage)



Mach-7L/Mach-7LX

Touch screen display and controller

A freely programmable, ARM-based display computer with 7.0" full-color TFT and touch screen.

Designed for advanced HMI functions in cost sensitive industrial vehicle applications, these devices can integrate several HMI functions like instrumentation, process GUI and video. The wide screen display offers good readability also in direct sunlight and the open software application platform enables easy realization of appealing user interfaces. It is suitable for both bracket mounting and integration in a dashboard. The interaction concept supports any combination of touch screen and programmable keys.

		Mach-7L		Mach-7LX				
			VALUE	STANDARD	ALL-INTEGRATED	NET + STANDARD	NET + ALL-INTEGRATED	
DISPLAY	7" WVGA, 800 x 480, 18 bit color depth, 700 cd/m ²	•	•	•	•	•	•	
INTERFACES								
- CAN	CAN, ISO 11898 2.0B, Bit-rate configurable 20–250 kbps.(1Mbit optional)	2 x	2 x	2 x	2 x	4 x	4 x	
- ETHERNET	1 x 10/100 Base-T	•	•	•	•	•	•	
- SERIAL	1 x RS232	•	•	•	•	•	•	
- USB	1 x USB 2.0	•	•	•	•	•	•	
- DIGITAL I/O	4 x Configurable as in or out			•	•	•	•	
- VIDEO IN	Analog Video in, NTSC or PAL	2 x	2 x	4 x	4 x			
- AUDIO	Stereo line out			•	•	•	•	
- WLAN	Built-in 801.11 b/g				•		•	
- GSM/GPRS	Built-in GSM/GPRS modem				•		•	
- BLUETOOTH	Built-in HCI Bluetooth				•		•	
- GPS	Built-in GPS receiver				•		•	

Mach-7L

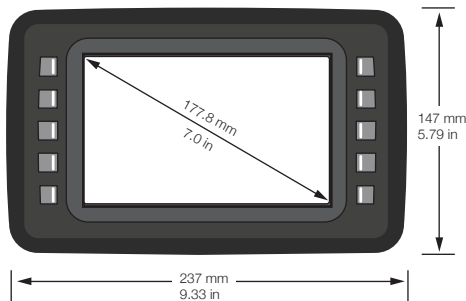

Mach-7L

32 bits ARM processor, with 256 MB DDR3 RAM (Scalable) 512 MB NAND Flash memory for Data (Scalable)

TFT display with anti-glare coated glass and Automatic Dimming.
LED back-lighted display (Optional touch screen)

Mach-7LX

32 bits ARM processor, with 256 MB DDR3 RAM and up to 4 GB Flash memory for Data.

TFT display with LED backlight and Automatic Dimming.

Housing - Aluminum (Plastic for XA Value model)
3 Push-buttons, On/Off increase/decrease light
Status LED - Application controllable in front panel
Buzzer - for sound notifications

Mach-7LX

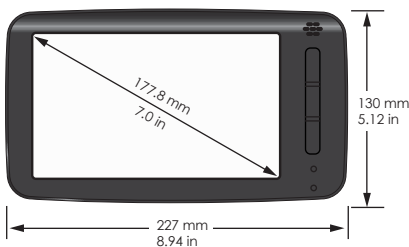

Housing - Plastic
10 application controlled soft-buttons
Buzzer - for sound notifications

Weight: 0.6 kg (1.32 lb)

Weight: 1.1 kg (2.43 lb)

Environmental Specifications

- EMC Conformity: 2004/108/EC, ISO 14982:2009
- IP66 and IP67 ingress protection
- Voltage: 12 or 24 V
9 - 32 VDC operating range
- Temperature range:
-25°C to +70°C
(-40°C to +85°C storage)
- Vibrations: 0,01g²/Hz 10-200 Hz
- Shock: 5 g/11ms 3x ±1000 bumps



Mach-7A

Made for Android™

The MACH-7A (available with a 7.0" LCD screen) is based on the Android operating system for maximized flexibility and is easily installed along with other instruments and control switches.

Engine and Generator; monitoring, diagnostics, parameter monitoring, Navigation, Charting and Entertainment are major features designed into the "Mach" series architecture.

The distinguishing features of the product are a highly customized and feature rich graphical user interface, touch screen, Bluetooth and Wireless or Wired remote keypads providing a rich environment to meet future expansion needs, including telematics and the ability for remote monitoring and control of assets.

DISPLAY	7" WVGA, 800 x 480, 16 bit color depth, 550 cd/m ² (Minimum)
INTERFACES	
- CAN	CAN Spec 2.0B Protocols include J1939, NMEA 2000 and SmartCraft
- SERIAL	Faria Bus, RS-485, RS-232
USB	1 x USB 2.0 in Deutsch connector
VIDEO IN	Analog Video in, NTSC or PAL
- AUDIO	Stereo input and Stereo output
BLUETOOTH	Built-in 2.1 (Optional)
- INPUTS	9 x in (8) Software configurable: Analog: 0-5V (1) Software configurable: Digital Pulsed input
- OUTPUTS	(3) Software configurable: Digital
- GPS	NMEA 0183 in Deutsch connector or built in (Optional)
- WLAN	Built-in 801.11 b/g
- GSM/GPRS	Built in (Optional)

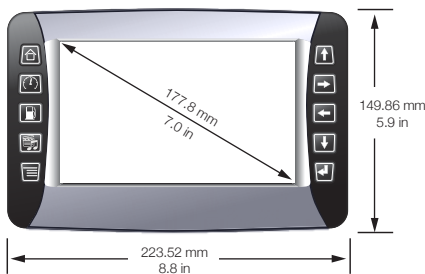

32 bits ARM processor, with 1 GB DDR3 RAM (Scalable)
2 GB NAND Flash memory for Data (Scalable)
microSD Memory Flash (built in)

TFT direct sunlight readable, touch screen display with anti-reflective coating.
LED back-lighted display

Housing - Plastic
10 application controlled soft-buttons
Buzzer - for sound notifications



Made for Android™



Environmental Specifications

- IP67 ingress protection
- Voltage: 12 or 24 V
9 - 32 VDC operating range



Mach-10L and Mach-12L

Touch screen display computer

An ARM-based touch screen display computer that provides the screen capabilities, interfaces and computing power to form integrated HMI systems for industrial vehicles.

The open software application platform for GUI, controls, diagnostics and mobile connectivity enables easy realization of total vehicle HMI systems.

		STANDARD	ALL-INTEGRATED	NET+STANDARD	NET+ALL-INTEGRATED
DISPLAY	10.4" XGA, 1024 x 768, LED, 480 cd/m ²	•	•	•	•
	12.1" XGA, 1024 x 768, LED, 400 cd/m ²	•			
INTERFACES					
- CAN	CAN, ISO 11898 2.0B, Bit-rate configurable 20–250 kbps. (1Mbit optional)	2 x	2 x	4 x	4 x
- ETHERNET	1 x 10/100 Base-T	•	•	•	•
- SERIAL	1 x RS232	•	•	•	•
- USB	1 x USB 2.0	•	•	•	•
- DIGITAL I/O	4 x Configurable as in or out	•	•	•	•
- VIDEO IN	4 x Analog Video in, NTSC or PAL	•	•		
- AUDIO	Stereo line out	•	•	•	•
- WLAN	Built-in 801.11 b/g		•		•
- GSM/GPRS	Built-in GSM/GPRS modem		•		•
- BLUETOOTH	Built-in HCI Bluetooth		•		•
- GPS	Built-in GPS receiver		•		•

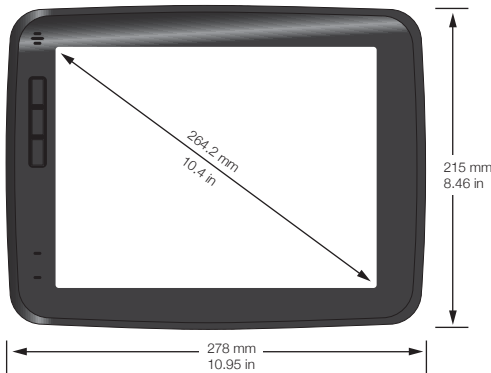

32 bits ARM processor, with 512 MB DDR3 RAM and 4 GB Flash memory for Data.

TFT display with LED backlight (4:3) with antiglare coating, and Automatic Dimming - available in 10" and 12" models

Housing - Aluminum

3 Push-buttons, On/Off increase/decrease light

Status LED - Application controllable in front panel

Buzzer - for sound notifications

Weight: 10" - 2.2 kg (4.85 lb) 12" - 3.1 kg (6.83 lb)

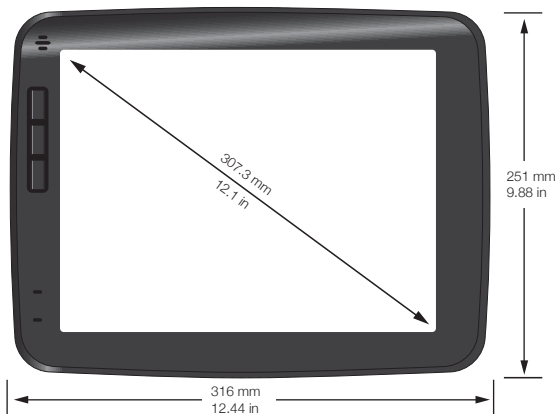

Environmental Specifications

- EMC Conformity: 2004/108/EC, EN61000-6-2:2005, EN61000-6-4:2007, ISO 14982:2009
- IP65 ingress protection
- Operating supply voltage range: 12 or 24 V
- Operating temperature range: -25 to +70°C (-40°C +85°C storage)



EntelNet

Wi-Fi Remote Engine Monitoring

Engine Monitoring and Alert Communications System.

The EntelNet™ service is a multi part system which combines the information received from the engine ECU (via CAN Bus), Analog (resistance, voltage, etc.) or Serial data (RS-232 for NMEA 0183, typical for GPS) and an over the air communications system, i.e. Wi-Fi, GSM or Iridium satellite to provide remote control and monitoring of on-board systems.

When an engine is malfunctioning the ECU transmits the area of the malfunction as a fault code.

The fault code is often used to turn on a lamp or an alert indicator. The EntelNet™ system records these fault codes and can send the data to the technician giving them a heads up of possible problems or a means to diagnose the engine's health remotely.



Get the technicians involved.

- No additional costs
- Send the engine and other critical data anywhere in the world to be diagnosed.
- Helps reduce warranty costs and can help lessen repair time.
- Data can be viewed on a secure website for remote systems diagnostics.



Connected directly to the CAN Bus, Real-Time data is sent by the EntelNet™ wireless module (Wi-Fi™).

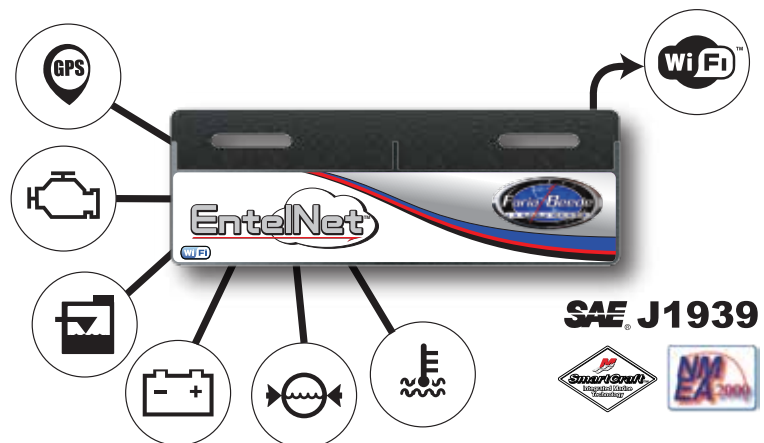

The data (GPS speed, Map position, Instrument data and CAN error codes) is displayed in an easy to read website and can be viewed by an internet capable Android® device i.e. Smart Phone, Tablet.

The engine information can then be sent to a repair facility, via e-mail, giving your repair technician a heads up that you're having problems.

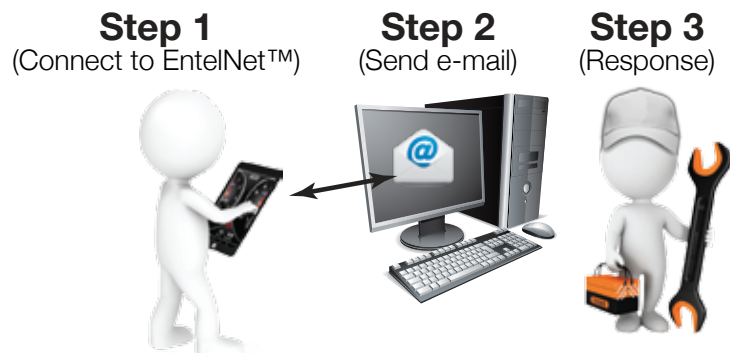



A complete solution for remote engine monitoring!

Wi-Fi Module only

SD0062

Faria Bus

- Requires MG3000



SD0066

Direct to J1939 CAN Bus



SD0065

Direct to NMEA CAN Bus



Custom OEM solutions available.

Wired to the CAN Bus with USB charging

SD0068

- NMEA & J1939 inputs
- up to 5 Analog inputs
- Digital switched outputs
- USB charging station

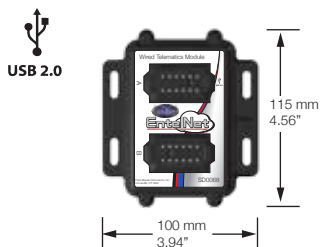

Application Made for Android®

Built from the ground up to be a touch-based user interface. The application is built directly on the Android operating system. Each screen is optimized to maximize the touch screen. Large target areas ensure smooth operations even in the harshest environments.



Custom OEM Application

Real-Time system data sent from the engine ECU and Analog inputs is displayed in the dedicated Android app. The system data, GPS speed, Map position, Instrument data, Asset monitoring data and CAN error codes are displayed in a highly customizable, virtual instrument dash board designed to fit your needs.

Built to be touched

Multiple "pages" can be displayed including:

- Standard and Secondary instruments
- Ballast Tank monitoring and control
- Fuel Management
- Error Codes



EntelNet

Advanced Telematic Solutions



Satellite and GSM Monitoring

750 DB

A powerful dual mode Iridium® Satellite and GSM MTU (Mobile Transmitting Unit).

Enhance Efficiency, Improve Safety

With the 750 DB you know where equipment is and if it's ready to work saving delays, work disruptions and logistics expense.

Efficiency: Track equipment location and utilization allowing for timely and accurate billing for services and equipment rentals. Receive early warning of equipment and engine faults to minimize breakdown and repair expense. Track equipment hours and fuel consumption to know when service is due, and log carbon emissions.

Safety: Employees can “check-in” or “check-out” from any location via an Iridium® Satellite linked Pendant. Workers can actively or passively call for help when in remote areas — in or away from their vehicle — engage escalation procedures in near real-time, and communicate with the office when out of cellular range.

Accountability: Monitor propulsion, extraction and generator engines for fuel efficiency, consumption, state of health and engine operating hours.

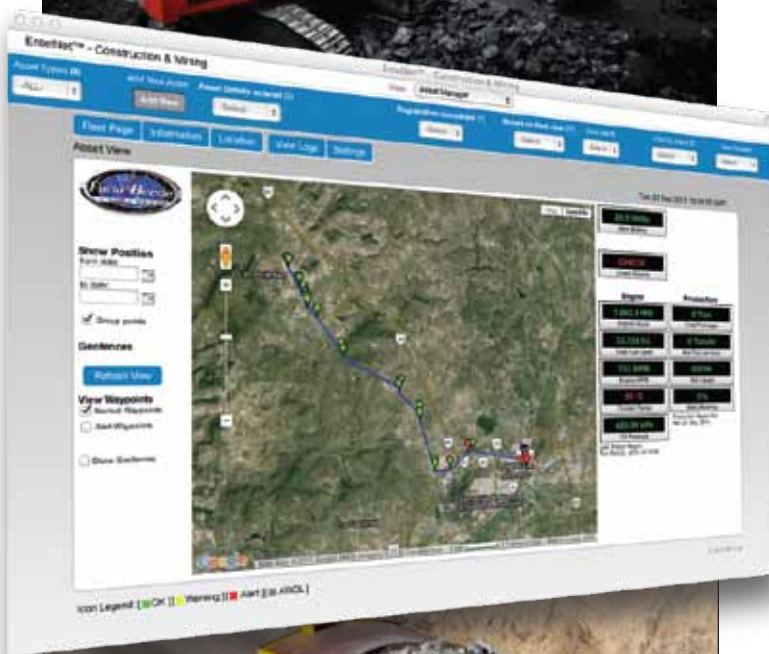

Advanced Features

- U-blox 50 Channel GPS for highly accurate positioning
- Sierra Wireless Quad-Band GSM Module
- Iridium Satellite Modem powered by Qualcomm
- Low Power Draw
 - Power Conditioning
 - Reverse polarity protection
 - Re-settable internal fuse
- Interface - Weather resistant Deutsch, DT Series connectors
- Compact, rugged injection molded case. IP-64 Rated
- On-board J1708 and J1939 CAN and wired OBDII interfaces to provide vehicle data and reporting of diagnostic codes
- RS232, RS422 and RS485 interfaces
- 2MB of compact flash RAM for data logging that can be requested over the air or downloaded locally
- Four factory configured I/O's

RUGGED. REMOTE. RELIABLE.

An Intrinsically Safe solution

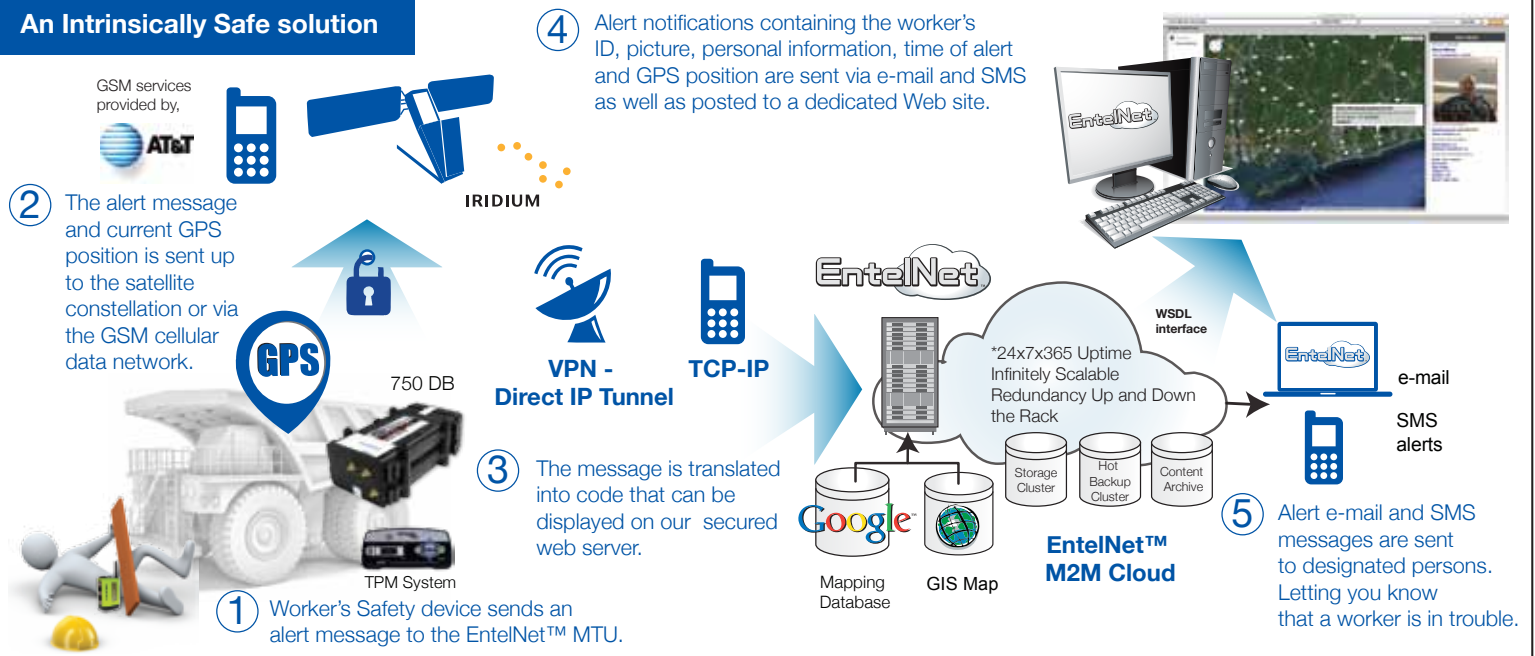

All of our hardware is built on ISO-9001 2008 certified production lines and tested for use in the harshest C & I, Mining, Oil & Gas and Maritime environments. From the North Slopes of Alaska, to Workboats in the North Sea, you can be confident that your EntelNet™ Telematics solution will continue to perform.

Dimensions and Weight

L:	9"	(229 mm)
W:	4.625"	(118 mm)
H:	3"	(76 mm)
	3 lbs.	(1430 gr.)

Specifications

Voltage:	12 & 24V ready (9.5-36VDC power)
Operating Temperature:	-20C to +85C
Storage Temperature:	-40C to +85C
Water and Weather Resistance:	IP64
Humidity:	90% RH at 29°C for 24 hours
Shock Resistant:	MIL-STD-202, 50G
Vibration Resistant:	SAE J1455
Corrosion Resistant:	ASTM-B117-73, 48 Hr



Optional Features



LONEWorker

Man Down™ system

The worker worn device protects the lone worker by communicating an emergency message with the worker's GPS position real-time through the EntelNet™ MTU. This device also provides for two-way text messaging and is *certified Intrinsically Safe for use in hazardous environments.*

TPM System

Tire Pressure Management

Automatically displays the current tire pressures and provides alerts on pressure loss and overheating conditions that gives a fleet operator the ability to correct tire problems before they become irreversible or dangerous.



Active RF ID Tag

Asset Tracking system

- Asset tags are ideal for use on all types of assets (including those made from metal) for general tracking and monitoring applications.
- Tags can incorporate a motion sensor.
- Tags have an anti-tamper facility
- A unique ID Code and relevant product data are transmitted via intelligent firmware.
- Ultra-low power consumption with a typical 5-year battery life at 1.5-second beacon rate.
- Compact, rugged (IP-67) construction.

Suitable for: Mining Trucks, Excavators, Conveyers, Crushers and any other mobile asset used.

Serving Industry Leading Companies for more than 50 years.

Kubota



AM General



DOOSAN



HONDA MARINE



KOHLER



CHAPARRAL



Husqvarna

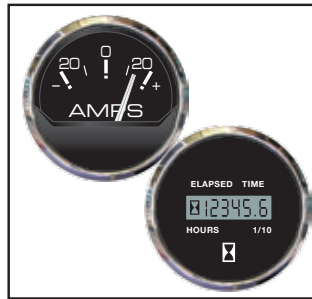

SUZUKI



POLARIS



Onan



EXCEL INDUSTRIES



OSHKOSH



TOHATSU Outboards



Bad Boy

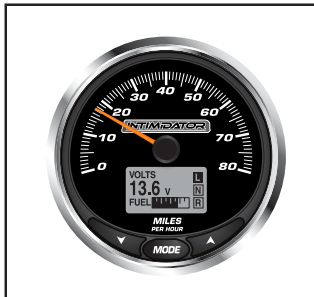

BRP



LOFA INDUSTRIES INC.



Made in the USA

Faria Beede Instruments, Inc.

P. O. Box 983
 Uncasville, CT 06382
 860.848.9271
 Fax: 860.848.2704

88 Village Street
 Penacook, NH 03303
 603.753.6362
 Toll-free: 800.451.8255
 Fax: 603.753.6201

Manufactured by the Faria Beede Instruments, Inc., Uncasville CT, Penacook, NH, USA • Copyright and all other rights reserved. Our products are continually being improved. Specifications may change without notice.

fm-002-0044 C 09/2015