

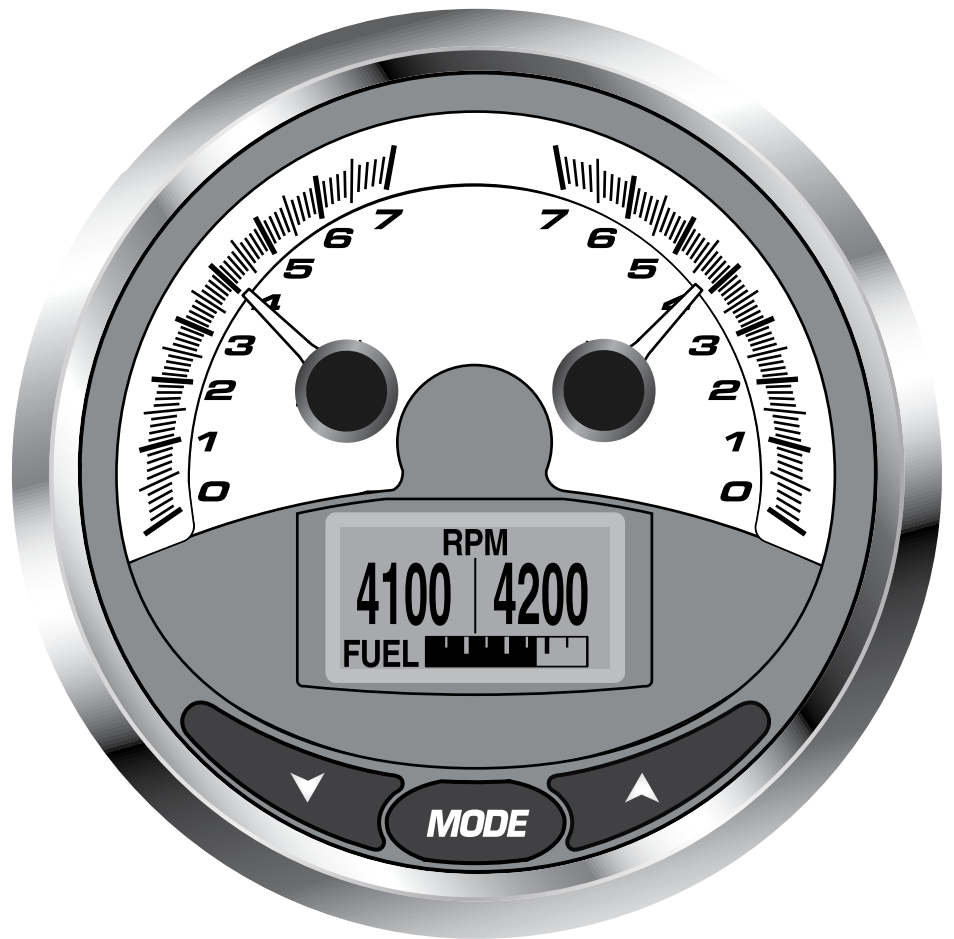

## **MG3000 with Dual Tachometer for NMEA2000 and J-1939**



**Owner's Manual**

IS0308 A ecn 8975



**IMPORTANT:** This User's Guide outlines the functionality and usage of the MG3000. Before using the MG3000, first read and understand ALL of the supplied product literature, as well as the boat's user's guide and outboard's operator's guide. This User's Guide should be stored onboard for reference at all times.

The photographs, illustrations and display screens used in this Guide might not depict actual models, figures, data fields, equipment or software versions, but are intended as representative views for reference only. The continuing accuracy of this Guide cannot be guaranteed.

† NMEA 2000 is a regulated trademark of the National Marine Electronics Association or its subsidiaries.

## About This Guide

**IMPORTANT:** Read this User's Guide carefully before using the MG3000 digital instrumentation. This User's Guide should be kept onboard at all times during operation.

## Need Assistance?

For any questions regarding the boat or outboard operation, please refer to the boat's user's guide, or outboard's operator's guide for support information.

For questions or problems regarding the MG3000, contact your dealer.

**IMPORTANT:** This guide was written for the MG3000 with the latest Software version: referenced below. Gauges with other software versions may have features not documented in this guide. To view the gauge software version, refer to Software Version page 16.

DATE	Rev.	DESCRIPTION	Program Version
5/29/2013	Pre	Preliminary release	PGF419_X10
6/25/2013	A	ecn 8975 (5/17/13) Manual Release	PGF419

# Index

Installation . . . . .	. 1
Wiring Diagram . . . . .	. 2
Power On . . . . .	. 2
System Setup . . . . .	. 3
Select System Language. . . . .	. 3
Offset Settings . . . . .	. 3
Engine Initialization . . . . .	. 3
Set Engine Manufacturer Type . . . . .	. 4
Default Display Units . . . . .	. 4
Tank Setup . . . . .	. 4
Remaining Fuel Source . . . . .	. 4
Number of Tanks . . . . .	. 5
Set Type of Tank . . . . .	. 5
Fuel Tank Setup . . . . .	. 5
Fuel Add To? . . . . .	. 5
Normal mode - Default Pages and Display Settings . . . . .	. 6
Menu Options . . . . .	. 6
Enter the Menu Options page . . . . .	. 6
Reset Fuel Totalizer . . . . .	. 7
Display Settings . . . . .	. 7
Contrast Settings . . . . .	. 8
Backlight Settings . . . . .	. 8
Lighting Source . . . . .	. 8
Fuel Level . . . . .	. 8
Setting the Fuel Level. . . . .	. 9
Adding Fuel to the Fuel Tank . . . . .	. 9
Trip Data . . . . .	. 10
View Trip and Season Data . . . . .	. 10
Resetting Trip and Season Data . . . . .	. 10
Edit Menu . . . . .	. 11
Appendix - System Menu . . . . .	. 11
Initialization. . . . .	. 11
System Language . . . . .	. 12
Audio Settings . . . . .	. 12
Warning Audio Settings (On or Off) . . . . .	. 12
Setting Saved Audio Setting . . . . .	. 12
Button Press Audio Setting . . . . .	. 13
All Sounds. . . . .	. 13
Clock Settings. . . . .	. 13
Change Clock Data Type . . . . .	. 14
Change Clock Time Offset . . . . .	. 14
Alarms . . . . .	. 14
Viewing Current Alarms . . . . .	. 14
Clear Alarms. . . . .	. 14
Set Units. . . . .	. 15
Performing a Self Test . . . . .	. 15
Software Version . . . . .	. 16
Perform a Master Reset . . . . .	. 16
Appendix - Fuel Set Up . . . . .	. 17
Fuel Tank Setup. . . . .	. 17
Setting the Fuel Level . . . . .	. 17
Adding Fuel to the Tank . . . . .	. 17
Setting the Tank Size . . . . .	. 18
Calibrating the Fuel Sender . . . . .	. 18

Low Fuel Warning Level . . . . .	18
Fuel Totalizer . . . . .	19
Reset the Fuel Totalizer . . . . .	19
Appendix - Max Speed . . . . .	20
View Max Speed . . . . .	20
Resetting Max Speed . . . . .	20
Appendix - Display Settings. . . . .	21
Setting the Number of Data Pages. . . . .	21
Screen Setup . . . . .	21
Setting the Line 2 Data . . . . .	22
Data Page Auto Scrolling Setting . . . . .	22
Change the Auto Scrolling Interval Time . . . . .	22
LCD Color . . . . .	23
Appendix - Data Sources. . . . .	24
Tanks . . . . .	24
Engine . . . . .	24
Engine Maintenance Interval . . . . .	25
Reset the Maintenance Interval . . . . .	25
View Engine Type. . . . .	25
Trim . . . . .	26
Calibrating Trim Sender . . . . .	26
Battery . . . . .	26
Oil Pressure . . . . .	27
Water Temp . . . . .	27
Air Temp. . . . .	27
Speed . . . . .	28
Steer Angle. . . . .	28
Appendix - Pop up Messages . . . . .	29
Turn Pop Up Alerts On or Off . . . . .	29
Set Pop Up Alerts Threshold Value . . . . .	29
Set Pop Up Alerts Duration . . . . .	29
Set Custom Alerts . . . . .	30
Trouble Shooting . . . . .	31
Engine Warnings . . . . .	31
Network Trouble shooting Chart . . . . .	32
Abbreviations Used . . . . .	33
Supported PGNs . . . . .	34
Warning Buzzer . . . . .	34

## Installation

### Description

The MG3000 instruments use a “plug and play” networking technology based on NMEA 2000 data communication standards (National Marine Electronics Association) and/or SAE J-1939. These standards provide communications through a serial data network utilizing a Controller Area Network (CAN) integrated circuit (IC). The network operates at 250 kb/second and allows multiple electronic devices to be connected together on a common channel for easy information sharing. Multiple digital displays can be used to monitor and broadcast equipment and engine data.

The MG3000 is controlled by a three-button keypad. The buttons and a brief description of their uses:

- UP and DOWN: Used to scroll through available pages in Normal Mode or options within the system menus.
- MODE: Used to access system menus, a short push of less than one second exits a menu and a long push of greater than one second makes a selection.

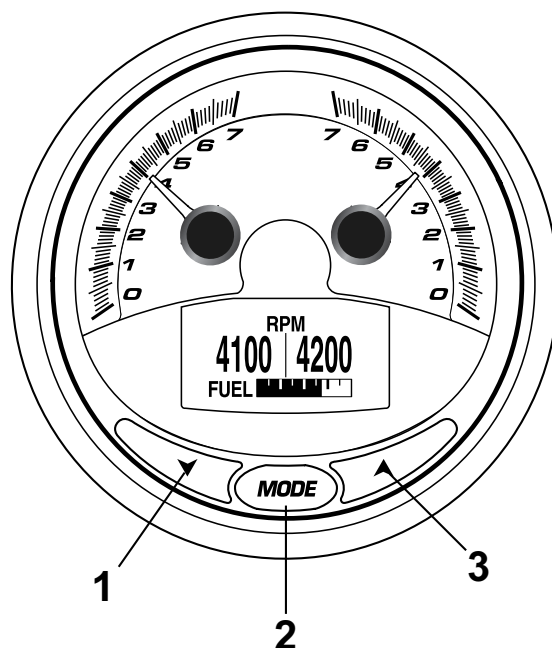

1. DOWN button
2. MODE button
3. UP button

### Panel Thickness

Instruments can be mounted in panels up to 1" (13 mm) thick and in panels up to 1.5" with trimming the back clamp.

### Hole Sizes

**IMPORTANT:** Check space behind panel to be sure there is adequate clearance for instruments exists before drilling panel.

4" - Cut a 3 3/8" (85 mm) diameter hole in the panel for the 4" instruments.

5" - Cut a 4 3/8" (112 mm) diameter hole in the panel for the 5" instruments.

### Attaching The Back Clamp

Insert instrument into the panel cut-out. Slide back clamp on gauge, place washer and finger tighten the nut (6-8 inch pounds), repeat for second stud.

# MG3000 Wiring Diagram

Tachometer

Speedometer

Pitot connection for Speed.

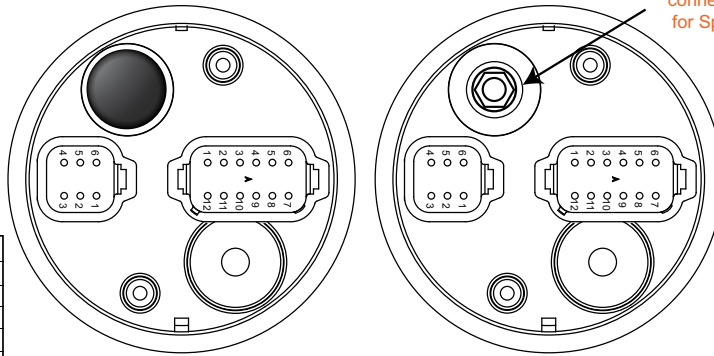

12- pin connector

Pin 1	7.7 vDC (Faria Bus +)
Pin 2	Faria Bus A
Pin 3	Faria Bus B
Pin 4	Ground
Pin 5	12vDC Ignition
Pin 6	N/C
Pin 7	Fuel Tank Level (Analog)
Pin 8	Fresh Water Level (Analog)
Pin 9	• NMEA B+ • J1939 12 vDC Ignition (jumper to pin 5)
Pin 10	• NMEA Ground • J1939 Shield
Pin 11	• NMEA CAN Hi (+) • J1939 CAN Hi (+)
Pin 12	• NMEA CAN Low (-) • J1939 CAN Low (-)

12- pin connector

Pin 1	7.7 vDC (Faria Bus +)
Pin 2	Faria Bus A
Pin 3	Faria Bus B
Pin 4	Ground
Pin 5	12 vDC Ignition
Pin 6	N/C
Pin 7	N/C
Pin 8	N/C
Pin 9	7.7 vDC (Faria Bus +)
Pin 10	Faria Bus A
Pin 11	Faria Bus B
Pin 12	Ground

Jumper required for the J1939 harness and is **Not required** for the NMEA2000 harnesses.

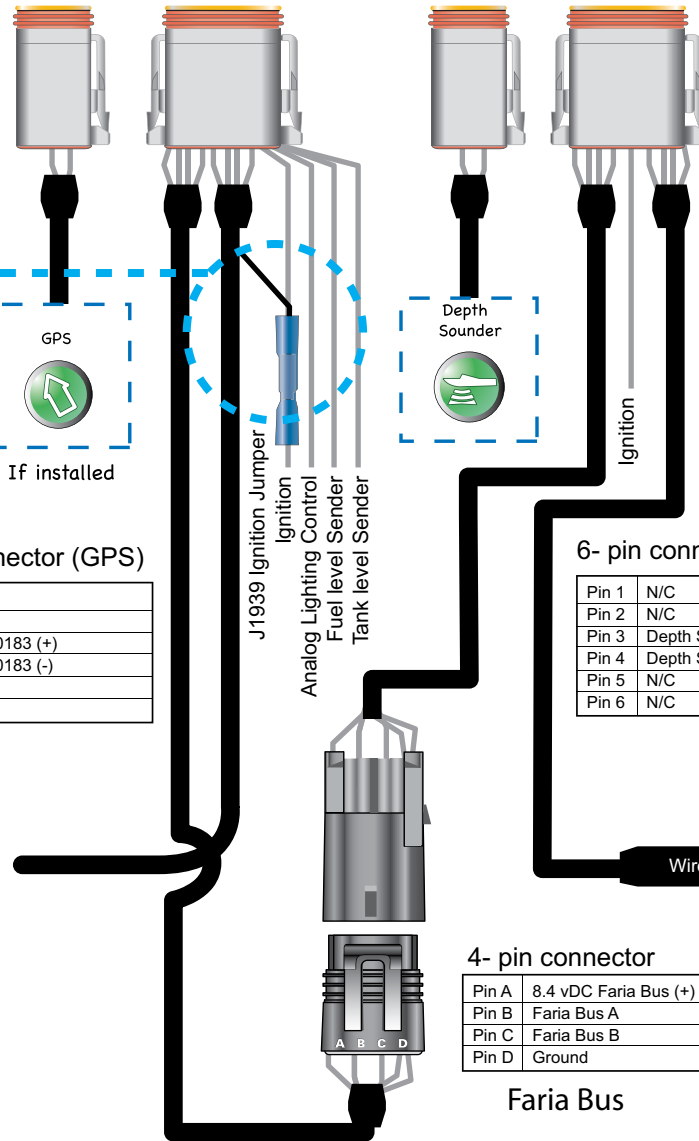

6- pin connector (GPS)

Pin 1	N/C
Pin 2	N/C
Pin 3	NMEA 0183 (+)
Pin 4	NMEA 0183 (-)
Pin 5	N/C
Pin 6	N/C

6- pin connector (Depth)

Pin 1	N/C
Pin 2	N/C
Pin 3	Depth Signal (+)
Pin 4	Depth Signal (-)
Pin 5	N/C
Pin 6	N/C

Multifunction Gauge

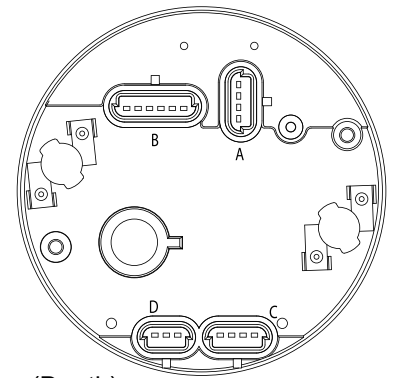

4- pin connector

Pin A	8.4 vDC Faria Bus (+)
Pin B	Faria Bus A
Pin C	Faria Bus B
Pin D	Ground

Information from the ECU

4- pin connector

Pin A	8.4 vDC Faria Bus (+)
Pin B	Faria Bus A
Pin C	Faria Bus B
Pin D	Ground

Faria Bus

Faria Bus  
(To other gauges)

## Power On

Turn the ignition key to the ON position. It is not required to start the engine for system initialization. The power on sequence for the MG3000 consists of a Self-Test which occurs at every power on event. The Self-Test process consists of the following steps:

- 1) If initialization is complete, the LCD will display SELF TEST. All of the lights in the MG3000 blink. Dial lights first, LCD backlights and then warning lights.
- 2) All system pointers will return to the zero position.
- 3) All system pointers will sweep to full scale.
- 4) All system pointers will go to current value.

**SELF TEST**  
SOFTWARE REV.  
PGFXXX\_XX

When the Self-Test is complete, if the gauge displays data then the system initialization has already been completed. To customize the data displayed in the LCD go to Display Settings on page 21.

Otherwise, if this is the first time you have powered on your MG3000, you will be prompted to System Setup. Complete the required system setup.

## System Setup (MG3000)

MG3000 initialization is required for the installed system to operate correctly. In order to complete the initialization process the user must select the default language, set the number of engines in the system, set the identifier of the engine to monitor, select the system default units and setup the fuel system information. The following sections describe the steps necessary to complete the MG3000 initialization.

### Select System Language

The first part of the initialization is selecting the language for the system.

- 1) Use the UP or DOWN buttons to select the desired language to be used. The available languages are: ENGLISH, SPANISH, FRENCH, ITALIAN and GERMAN.
- 2) Press and hold the MODE button to save the language selection. The LCD screen displays SETTING SAVED! along with an audible beep.

**LANGUAGE**  
**ENGLISH**  
SPANISH  
ITALIAN

### Clock Offset Settings

The Clock data field is available if a GPS is connected to the system. Select the current time zone offset for the Clock to show the correct time.

- 1) Use the UP or DOWN button to select the correct CLOCK OFFSET value.
- 2) Press and hold the MODE button to save the setting. The LCD screen displays SETTING SAVED! and the MG3000 issues an audible beep.

**SELECT**  
**CLOCK OFFSET**  
**GMT**  
GMT +1

Once System Setup is completed and a GPS is connected to the MG3000 you can make further adjustment to the clock display. See Clock Settings, page 13.

### Engine Initialization

Note: Some manufacturers may have already set this value for you, if so skip this step.

- 1) Use the UP or DOWN buttons to select the number of engines installed on the



boat. The MG3000 supports up to 5 engines.

- 2) Press and hold the MODE to save the number of engines. The LCD screen displays SETTING SAVED! and the MG3000 issues an audible beep.

If more than one engine is installed continue to steps 3 and 4.

- 3) Use the UP and DOWN buttons to select the engine identifier. The engine identifier assigns each MG3000 to monitor a specific engine.

The engine can be identified as either: PORT, MID PORT, MID STARBOARD and STARBOARD,. If only one engine is identified the MG3000 will automatically select the engine identifier SINGLE and save.

- 4) Press and hold the MODE button to save the setting. The LCD screen displays SETTING SAVED! and the MG3000 issues an audible beep.

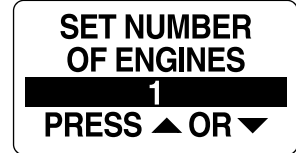

## Set Engine Manufacturer Type

Set the engine manufacturer in the ENGINE TYPE menu. If you are using Yamaha, Honda or Cummins engines select that type in the menu. This sets up the MG3000 so that it can use the information supplied by the engine ECU on the bus. For other engine types using the NMEA 2000 protocols select NMEA STD.

Note: Some manufacturers may have already set this value for you, if so skip this step.

- 1) Use the UP or DOWN buttons to select engine type; NMEA STD, YAMAHA, HONDA, CUMMINS.
- 2) Press and hold the MODE button to save the selection. The LCD screen displays SETTING SAVED! and the MG3000 issues an audible beep.

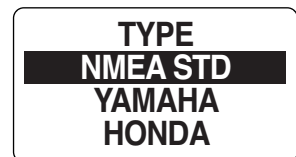
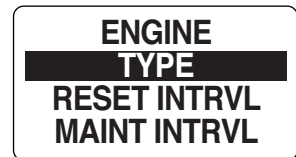

## Default Display Units

The default display units will set the units for all data fields in the instrument package. Using the advanced settings, the user can adjust individual data field's units to differ from the default units, see page 15 Set Units.

- 1) Use the UP or DOWN buttons to select the desired display units. Available display options are: US and EURO.
- 2) Press and hold the MODE button to save the selection. The LCD screen displays SETTING SAVED! and the MG3000 issues an audible beep.



## Tank Setup

**Important:** All fuel tank information MUST be set up in the PORT MG3000 if more than one MG3000 is in use.

## Remaining Fuel Source

- 1) Use the UP and/or DOWN buttons to select the correct REM FUEL SRC.
- 2) Press and hold the MODE button to save the selection. The LCD screen displays SETTING SAVED! and the MG3000 issues an audible beep.

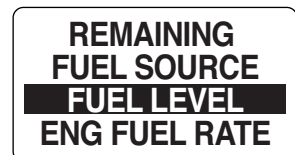

Note: The Remaining Fuel Source is the source for the remaining fuel in the system. This value is used to calculate various Fuel Economy functions in the MG3000. Fuel Level is the information provided by the Fuel Level sender and Eng Fuel Rate is the

information provided by the engine ECU.

## Number of Tanks

- 1) Use the UP or DOWN buttons indicate the number of fuel tanks in the system. The MG3000 supports up to five (5) fuel tanks.
- 2) Press and hold the MODE button to save the selected number of fuel tanks. The LCD screen displays SETTING SAVED! and the MG3000 issues an audible beep.

SET NUMBER OF  
TANKS  
1  
PRESS ▲ OR ▼

## Set Type of Tank

For each tank indicated in the system the MG3000 will ask the type of tank used. Tank types available are FUEL, FRESH WATER, GREY WATER, BAIT WELL, OIL LEVEL, BLACK WATER and BALLAST. “#” indicates the number of tank selected.

- 1) Use the UP and/or DOWN buttons to select the type of tank in SET TANK # TYPE.
- 2) Press and hold the MODE button to save the selection.

SET TANK #  
TYPE  
FUEL  
FRESH WATER

**Note:** If you select FUEL you will be taken to the FUEL TANK SETUP menu to complete the FUEL settings, go to step 3. Otherwise select the remaining type of tanks available on your boat. When finished go to step 6 and complete INITIALIZATION.

## Fuel Tank Setup

- 3) Use the UP and DOWN buttons to set the capacity of the fuel tank. Holding a button will increment/decrement in a more rapid manner.
- 4) Press and hold the MODE button to save the capacity of the fuel tank. The LCD screen displays SETTING SAVED! and the MG3000 issues an audible beep.
- 5) Repeat steps 1 - 4 for the additional fuel tanks.
- 6) When Fuel Tank Setup is complete, and all available tank types have been identified the MG3000 initialization is complete and the display will read “BASIC INITIALIZATION COMPLETE!”. The MG3000 issues an audible beep.

SET FUEL  
T1: FUEL  
50.0 GAL  
PRESS ▼ OR ▲

BASIC  
INITIALIZATION  
COMPLETE

## Normal Mode - Default Pages and Display Settings

When initialization is complete the MG3000 is ready for use. The LCD display will show the Normal mode default data page.

Use the UP or DOWN buttons to scroll through the Normal mode default display pages.

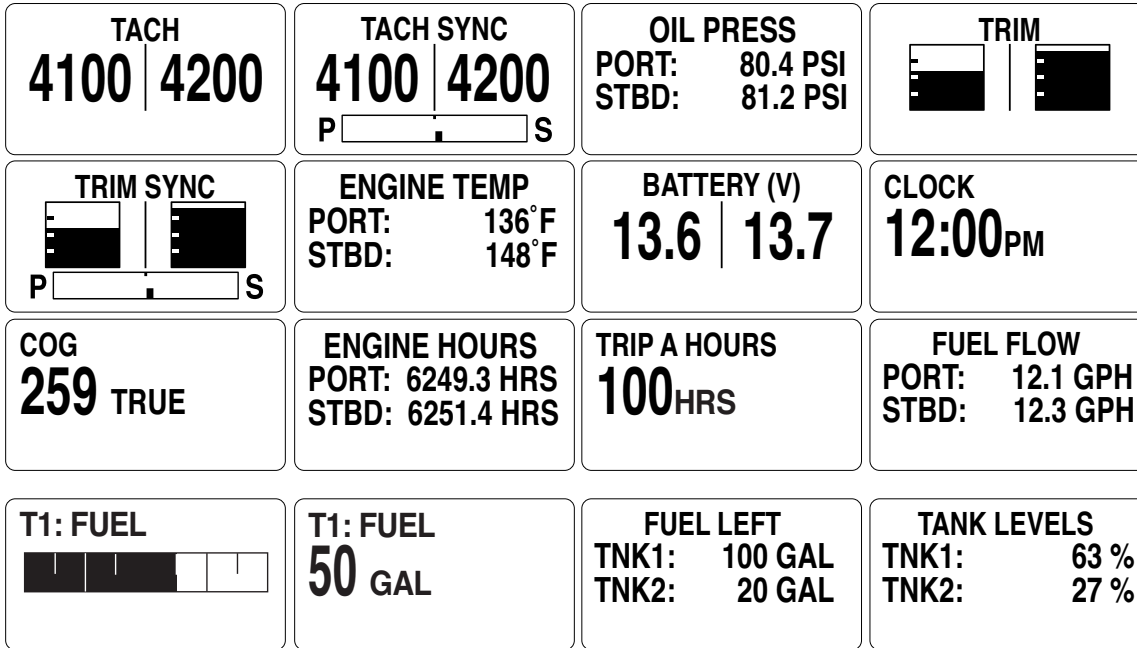

Single Fuel Tank display

Multiple Fuel Tank display

## Options menu

While in Normal mode, pressing the MODE button once will show the Options menu.

The Options menus are:

- **RESET TOTALIZER:** Resets the total fuel used.
- **TRIP DATA:** records Engine Hours, Fuel Used, Odometer and Fuel Rate.
- **FUEL LEVEL:** is used for quick access to add fuel to one of the fuel tanks.
- **EDIT MENU:** is used to make global MG3000 settings changes.
- **CONTRAST:** is used to adjust the MG3000 display.
- **LIGHTING:** is used to adjust the instrument's lighting level(s).
- **DEPTH:** is used to set the depth of the water alarms (if available)

For more information about the Option menu look in the back of this manual in the Appendix section.

**Note:** Some functions may not be present in your version of the MG3000 program. Engine and Boat manufactures have the ability to customize the program to fit their build requirements. If you are looking for a feature listed in the Appendix and your MG does not show the function required please consult your Engine and Boat manufacturer's User manual.

## Enter the Options menu page.

- 1) From the NORMAL mode, press the MODE button once to display the Options menu.
- 2) Use the UP or DOWN buttons to select the desired menu option.
- 3) Press and hold the MODE button to enter the desired menu option.

HOLD MODE  
TO ENTER  
EDIT MENU  
LIGHTING

**Note:** LIGHTING is available only if the source for LCD, DIAL or SYSTEM is set to INSTRUMENT.

To reset the Totalizer Fuel Used:

## Reset Fuel Totalizer

The Fuel Totalizer is used when more than one Fuel Tank is installed in the system. The Totalizer will monitor all of the installed Fuel Tanks, gather the data and combine for fuel usage data that represents the entire system. The MG3000 automatically collects the fuel data based on the settings in the individual tank settings completed in SYSTEM SETUP. If you have not completed or wish to change the individual tank set up go to FUEL SETUP on page 17.

Use the Fuel Totalizer to monitor select TFUEL USED, TFUEL LEFT, TFUEL INST TFUEL FLOW or TFUEL AVG in the default pages.

TFUEL USED - Total Fuel Used - Displays the total amount of fuel used since the last reset.

TFUEL LEFT - Total Fuel Left - Displays the total amount of fuel left since last reset.

TFUEL INST - Total Instantaneous Fuel Flow - Measures how much fuel is flowing at this time for all engines combined into one amount.

TFUEL AVG - Total Average Fuel Flow - Average of fuel flow from all engines taken over a period of time.

The only user selectable function in the Fuel Totalizer is the RESET TOTALIZER.

**Warning:** Resetting the totalizer will also reset all collected Fuel economy data.

To reset the Fuel Totalizer:

- 1) Press and hold the MODE button from the NORMAL mode.
- 2) Use the UP or DOWN buttons to select RESET TFUEL.
- 3) When prompted, RESET DATA? use the UP or DOWN buttons to select YES to reset the totalizer fuel used, or select NO to exit.
- 4) Press and hold the MODE button to save the setting. The LCD screen displays SETTING SAVED! and the MG3000 issues an audible beep.

HOLD MODE  
TO ENTER  
RESET TOTALIZR  
TRIP DATA

TOTALIZER  
RESET?  
NO  
YES

## Display Settings

Adjusting the display settings may improve visibility.

- 1) From the NORMAL mode, press the MODE button once to view the Options menu.
- 2) Press the UP or DOWN buttons to select LIGHTING or CONTRAST.

HOLD MODE  
TO ENTER  
CONTRAST  
RESET TOTLIZR

- 3) Press and hold MODE to make the selection.
  - To adjust the contrast in the LCD display, go to Step 4.
  - To adjust the instrument and all connected gauge's backlight intensity, go to Backlight Settings.

## Contrast Settings

There are 20 defined contrast levels. The contrast level will change to negative mode, white font on dark background, halfway through the 20 predefined contrast settings.

- 4) Press the UP button to increase or the DOWN button to decrease the contrast level in the LCD display.
- 5) The contrast setting is automatically saved and synchronized to all gauges linked to the MG3000.

ADJUST  
LCD  
CONTRAST  
PRESS ▼ OR ▲

ADJUST  
LCD  
CONTRAST  
PRESS ▼ OR ▲

## Backlight Settings

By default the Dial Backlight (all gauges connected to the MG3000) and the Display Backlight (LCD) are synchronized, they get brighter or dimmer at the same time. Use the MG3000 to adjust the lighting options. Enter the Options menu (page 6), then:

- 1 Use the UP or DOWN button to select the LIGHTING to adjust.
- 2) Press and hold the MODE button to make the selection.
- 3) Use the UP or DOWN button to select the lighting level to adjust.

HOLD MODE  
TO ENTER  
LIGHTING  
CONTRAST

LIGHTING  
ADJUST LCD  
ADJUST DIAL  
ADJUST SYSTEM

From the MG3000 you can adjust the LCD lighting, Dial lighting and the System lighting, which will adjust all instruments connected to the MG3000.

- 4) Press and hold the MODE button to make the selection.
- 5) Use the UP button to increase the lighting intensity or press the DOWN button to dim the lighting intensity.
- 6) Press and hold the MODE button to save the setting. The LCD screen displays SETTING SAVED! and the MG3000 issues an audible beep.

ADJUST DIAL  
BRIGHTNESS  
100 %  
PRESS ▼ OR ▲

## Fuel Level

Use FUEL LEVEL to quickly add fuel amounts to each fuel tank and set the tank indicator FULL after a fuel fill up. By keeping accurate accounts of the fuel added to the tanks at fill up the MG3000 can help you by calculating accurate fuel economy values such as Fuel Flow, Range and Trip data.

Enter the Options menu (page 6) then:

- 1) Use the UP or DOWN buttons to select FUEL LEVEL.
- 2) Press and hold the MODE button to make the selection.
- 3) Use the UP or DOWN buttons to select the fuel tank to make an adjustment to.
- 4) Press and hold the MODE button to enter the selection.

HOLD MODE  
TO ENTER  
FUEL LEVEL  
EDIT MENU

SELCT TANK TO  
ADD FUEL TO  
T1: FUEL  
T2: FUEL

- 5) Follow the steps in the next sections.

## Setting The Fuel Level

Setting the Fuel Level is performed in the MG3000 identified as PORT if more than one MG3000 is in use. To set the fuel level to full:

- 1) From the NORMAL mode, press and hold the MODE button to enter the Options menu.
- 2) Use the UP or DOWN buttons to select FUEL LEVEL.
- 3) Press and hold the MODE button to make selection.
- 4) Use the UP or DOWN buttons to select which tank to add fuel to.
- 5) Press and hold the MODE button to make selection.
- 6) Use the UP or DOWN buttons to select SET FULL.
- 7) Press and hold the MODE button to set fuel tank to FULL.
- 8) At prompt, SET TANK FULL, use the UP or DOWN buttons to select YES, the fuel tank is indicating full, or NO to return to the SET FULL menu.

SELECT TANK TO  
ADD FUEL TO  
T#:FUEL  
T#:FUEL

T#: FUEL#  
SET FULL  
ADD FUEL

SET TANK FULL  
NO  
YES

**Note:** A full indication indicates that the amount of fuel added to the fuel tank is equal to the capacity of the fuel tank set up in the initialization setup. The MG3000 uses this number to calculate the Fuel economy calculations. An inaccuracy in this number will result in faulty calculations.

- 9) Use the MODE button to make the selection.

If YES was selected the LCD screen will display SETTING SAVED! and then return you to the SET FULL menu.

## Adding Fuel to the Fuel Tank:

- 1) From the NORMAL mode, press and hold the MODE button to enter the Options menu.
- 2) Use the UP or DOWN buttons to select FUEL LEVEL.
- 3) Press and hold the MODE button to make selection.
- 4) Use the UP or DOWN buttons to select which tank to add fuel to.
- 5) Press and hold the MODE button to make selection.
- 6) Use the UP or DOWN buttons to select ADD FUEL
- 7) Press and hold the MODE button to enter the TANK # ADD menu.
- 8) Use the UP or DOWN buttons to set the volume of Fuel that has been added to the fuel tank.
- 9) Press and hold the MODE button to save the setting. The LCD screen displays SETTING SAVED! and the MG3000 issues an audible beep.

T#: FUEL#  
ADD FUEL  
SET FULL

AMOUNT ADDED  
T#: FUEL#  
0.0 GAL  
PRESS ▲ OR ▼

**Note:** Holding the UP or DOWN button will increase or decrease the amount in a more rapid fashion.

## Trip Data

The Trip Data feature records ENGINE HOURS, FUEL USED, ODOMETER and FUEL RATE for two trips and the season. To view the Trip Data enter the Options menu (page 6), then:

- 1) From the NORMAL mode, press and hold the MODE button to enter the Options menu.
- 2) Use the UP or DOWN buttons to select TRIP DATA.
- 3) Press and hold the MODE button to make selection.
- 4) Follow the steps in the next sections.

HOLD MODE  
TO ENTER  
TRIP DATA  
FUEL LEVEL

TRIP DATA  
TRIP A  
TRIP B  
SEASON

### View Trip and Season Data

- 1) Use the UP or DOWN buttons to select TRIP A, TRIP B or SEASON.
- 2) Press and hold the MODE button to enter the selection.
- 3) Use the UP or DOWN buttons to select VIEW DATA.
- 4) Press and hold the MODE button to make a selection.
- 5) Use the UP or DOWN buttons to select information to be shown.

TRIP A DATA  
VIEW DATA  
RESET DATA

TRIP # FAVG  
X.X GPH  
TRIP # ODO  
X.X MI

**Note:** Available Trip information is; Fuel Average (FAVG) for trip Odometer (ODO), trip Fuel (FUEL) and trip Hours (HOURS).

### Resetting Trip and Season Data

- 1) Use the UP or DOWN buttons to select TRIP A, TRIP B, or SEASON.
- 2) Press and hold the MODE button to enter the selection.
- 3) Use the UP or DOWN buttons to select RESET DATA.
- 4) Press and hold the MODE button.

At the prompt: RESET DATA?

- 5) Use the UP or DOWN buttons to select YES to reset the data, or select NO to exit.
- 6) Press and hold the MODE button to reset the data. The LCD screen displays SETTING SAVED! and the MG3000 issues an audible beep.

TRIP A DATA  
RESET DATA  
VIEW DATA

TRIP A  
RESET?  
NO  
YES

## Edit Menu

While in Normal mode, pressing the MODE button once will show the Options menu. Use the UP or DOWN buttons until EDIT MENU is highlighted, then hold the MODE button to enter.

- **SYSTEM:** is used to make global MG3000 changes for Audio, perform a Self-Test or Master Reset and view the Software version.
- **CAL TRIM:** is used to calibrate the Trim tabs on your boat.
- **FUEL SETUP:** is used to set and manage the fuel devices.
- **MAX SPEED:** The MG3000 records the highest speed during the last period since reset.
- **DISPLAY:** is used to edit the data pages that are shown in Normal Mode as well as adjust lighting and contrast.
- **DATA SOURCES:** is used to select the data sources for Engine parameters, trim, battery, oil sender and analog inputs.
- **CUSTOM ALARMS:** is used to set special pop up alerts in the MG3000.
- **POP UPS:** is used to set user definable information pop ups when changes occur in a monitored data value.

**HOLD MODE  
TO ENTER  
EDIT MENU  
LIGHTING**

**Note:** Although the manual may identify a particular function as being part of the MG3000 architecture individual functions may not be available for your installation. Check with your engine and boat manufacturer for function availability.

## System

Use the SYSTEM edit menu to initialize the MG3000, set the system language, control the Audio settings, perform a Self-Test or Master Reset and to view the current software version for the MG3000. The SYSTEM edit menu is used for entering diagnostic mode and to enter the engine into winterize mode. Follow the steps below to view the SYSTEM edit menu options.

- 1) From the NORMAL mode, press the MODE button once to enter the Options menu.
- 2) Use the UP and/or DOWN buttons to select EDIT MENU.
- 3) Press and hold the MODE to enter the EDIT MENU options.
- 4) Use the UP and/or DOWN buttons to select SYSTEM.
- 5) Press and hold the MODE button to make the selection.

**EDIT MENU  
SYSTEM  
CAL TRIM  
FUEL SETUP**

## Initialization

When the MG3000 is first powered on the instrument goes into the INITIALIZATION mode.

If you wish to initialize the MG3000 after the initial set up was completed, enter the SYSTEM menu (page 11) then:

- 1) Use the UP or DOWN buttons to select INITIALIZE.

**SYSTEM INFO  
INITIALIZE  
LANGUAGE  
AUDIO**

**ENTER  
INITIALIZATION  
YES  
NO**



- 2) Press and hold the MODE button to make selection.
- 3) Use the UP or DOWN buttons to select YES to initialize or NO to return to the EDIT menu.
- 4) Press and hold the MODE button to make selection.

To complete the initialization process select the default language, set the number of engines in the system, set the identifier of the engine to monitor, select the system default units and setup the fuel system information.

If the MG3000 has not been initialized previously when the power is first applied the program will automatically start up into the INITIALIZATION mode. See System setup on page 2.

## System Language

Enter the SYSTEM menu (page 11) then:

- 1) Use the UP or DOWN button to select LANGUAGE.
- 2) Press and hold the MODE button to make the selection.
- 3) Use the UP or DOWN buttons to select the desired language to be used. The available languages are: ENGLISH, SPANISH, FRENCH, ITALIAN and GERMAN.
- 4) Press and hold the MODE button to save the language selection. The LCD screen displays SETTING SAVED! along with an audible beep.



## Audio Settings

The Audio menu is used to turn on or off the buzzer for warnings. To make changes to the system audio enter the SYSTEM menu (page 11) and then:

**Note:** The audio setting ALL, should NOT be used to turn OFF warnings.

- 1) Use the UP or DOWN buttons to select AUDIO options.
- 2) Press and hold the MODE button to make the selection.
- 3) Use the UP or DOWN buttons to select the desired menu.
- 4) Press and hold the MODE button to make the selection.



### Warning Audio Setting (ON or OFF)

Use WARNING BEEP to turn the buzzer ON or OFF while a warning is occurring in the MG3000. To change the setting enter the SYSTEM menu (page 11) then enter the AUDIO menu:

**IMPORTANT:** Turning off the WARNING BEEP is **NOT** recommended.

- 1) Use the UP or DOWN buttons to select the WARNING BEEP.
- 2) Press and hold the MODE button to enter the selection.
- 3) When prompted, select the WARNING BEEP AUDIO STATUS. Use ON to have the MG3000 beep when a warning occurs, or OFF to turn off the beep and return to the AUDIO options menu.
- 4) Press and hold the MODE button to save the setting. The LCD screen displays



SETTING SAVED! and the MG3000 issues an audible beep.

### Setting Saved Audio Setting

Use SET SAVED to turn the buzzer ON or OFF after a setting is saved in the MG3000.

To change the setting enter the SYSTEM menu (page 11), then:

- 1) Use the UP or DOWN buttons to select the SET SAVED.
- 2) Press and hold the MODE button to enter the selection.
- 3) When prompted, select the SETTING SAVED AUDIO STATUS. Use ON to have the MG3000 beep when saving a setting, or OFF to turn off the beep and return to the AUDIO options menu.
- 4) Press and hold the MODE button to save the setting. The LCD screen displays SETTING SAVED! and the MG3000 issues an audible beep.

SETTING SAVED  
AUDIO STATUS  
ON  
OFF

### Button Press Audio Setting

Use BUTTON PRESS to turn the buzzer on or off whenever a button is pressed on the MG3000.

Enter the SYSTEM menu (page 11) then:

- 1) Use the UP or DOWN buttons to select the BUTTON PRESS.
- 2) Press and hold the MODE button to enter the selection.
- 3) When prompted, select the BUTTON PRESS AUDIO STATUS. Use ON to have the MG3000 beep after every button press, or OFF to turn off the beep and return to the AUDIO options menu.
- 4) Press and hold the MODE button to save the setting. The LCD screen displays SETTING SAVED! and the MG3000 issues an audible beep.

AUDIO SETTING  
BUTTON PRESS  
ALL  
WARNING BEEP

BUTTON PRESS  
AUDIO STATUS  
ON  
OFF

### All Sounds

Use ALL to turn the buzzer ON or OFF for ALL the Audio menu options.

**Note:** The audio setting **ALL**, *should NOT be used to turn OFF warnings.*

Enter the SYSTEM menu (page 11) then:

- 1) Use the UP or DOWN buttons to select the ALL
- 2) Press and hold the MODE button to enter the selection.
- 3) When prompted, select the ALL BEEPS AUDIO STATUS. Use ON to have the MG3000 beep for all audio feedback or OFF to turn off the beep and return to the AUDIO options menu.
- 4) Press and hold the MODE button to save the setting. The LCD screen displays SETTING SAVED! and the MG3000 issues an audible beep.

AUDIO SETTING  
ALL  
WARNING BEEP  
SET SAVED

ALL BEEPS  
AUDIO STATUS  
ON  
OFF

### Clock Settings

You will be asked to select the current time zone offset for the Clock to show the correct time in the INITIALIZATION mode when you first start the MG3000. **The Clock data**

**field is available only if a GPS is connected to the system.** Clock data can be shown using a 12 or 24 hour format.

To set the Clock, enter the SYSTEM menu (page 11), then:

- 1) Use the UP or DOWN buttons to select CLOCK SETTING.
- 2) Press and hold the MODE button to enter the selection.

SYSTEM INFO  
**CLOCK SETTING**  
 SET UNITS  
 SELF-TEST

**To change the Clock Data Type:**

- 3) Use the UP and/or DOWN buttons to select TYPE.
- 4) Press and hold the MODE button to enter the selection.
- 5) Use the UP or DOWN button to select 12 HOUR or 24 HOUR time format.
- 6) Press and hold the MODE button to save the selection. The LCD screen displays SETTING SAVED! and the MG3000 issues an audible beep.

SET CLOCK  
 DISPLAY TYPE  
**12 HOURS**  
 24 HOURS

**To change the time offset:**

- 1) Use the UP and/or DOWN buttons to select TIME OFFSET.
- 2) Press and hold the MODE button to enter the selection.
- 3) Use the UP or DOWN button to select the correct TIME OFFSET value.
- 4) Hold the MODE button to save the selection. The LCD screen displays SETTING SAVED! and the MG3000 issues an audible beep.

SELECT  
 CLOCK OFFSET  
**GMT**  
 GMT +1

## Alarms

The MG3000 digital gauge package is equipped with an ALARMS menu that enables the user to view current and past alarms.

### Viewing Current Alarms

To view the current alarms enter the SYSTEM menu (page 11), then:

- 1) Use the UP or DOWN buttons to select ALARMS.
- 2) Press and hold the MODE button to enter the selection.
- 3) Use the UP or DOWN buttons to highlight VIEW.
- 4) Press and hold the MODE button to make the selection.

ALARMS  
**VIEW**  
 CLEAR

CHECK  
 ENGINE  
 ACTIVE  
 06/10/09

If there are current alarms, the screen will show the first alarm. Use the UP or DOWN buttons to view all alarms. When finished, press the MODE button to escape.

**Note:** Date information is only available if a NMEA GPS antenna is in the system.

If there are no current alarms, the screen will display NO STORED ALARMS FOUND! for two seconds and the MG3000 issues an audible beep. .

### Clear Alarms

To clear all alarms in the MG3000 enter the SYSTEM menu (page 11), then:

ALARMS  
**CLEAR**  
 VIEW

**Warning:** This will clear all recorded alarms the MG3000 has recorded and this action **CAN NOT BE UNDONE**. It is best to leave this action to a trained service technician.

- 1) Use the UP or DOWN buttons to select ALARMS.
- 2) Press and hold the MODE button to enter the selection.
- 3) Use the UP or DOWN buttons to highlight CLEAR.
- 4) Press and hold the MODE button to make the selection.
- 5) Use the UP or DOWN buttons to select YES.
- 6) Press and hold the MODE button to save the selection. The LCD screen displays SETTING SAVED! and the MG3000 issues an audible beep.

### Set Units

Use the Set Units menu to change the units for the data recorded in the MG3000. Use the Set Units menu to change the units on all data or individual data type. For instance, change all units from US standard to Euro. The units of the following information can be changed; ALL UNITS, VOLUME, DISTANCE, SPEED, TEMPERATURE, DEPTH, PRESSURE, GPS COG and FLOW RATE. To make a change to the units, enter the SYSTEM Menu (page 11) then:

- 1) Use the UP or DOWN buttons to select SET UNITS.
- 2) Press and HOLD the MODE button to enter the selection.
- 3) Use the UP or DOWN buttons to select the data type to make a change to.
- 4) Press and hold the MODE button to enter the selection.
- 5) Use the UP or DOWN buttons to select the desired units type.



Data	Units Available		
All Units	US	EURO	
Volume	Gal	Liter	
Distance	Mile	Kilometer	Nautical Mile
Speed	MPH	KMH	Knots
Temperature	Fahrenheit	Celsius	
Depth	Feet	Meter	Fathom
Pressure	PSI	BAR	kPA
GPS COG	True	Magnetic	
Flow Rate	Gal Per HR	Liter Per HR	

- 6) Press and hold the MODE button to save the selection. The LCD screen displays SETTING SAVED! and the MG3000 issues an audible beep.

### Performing A Self Test

Use the SELF-TEST feature to test the MG3000 and gauges connected to the MG3000 are communicating. To perform a Self-Test, enter the System Menu (page 11) then:

- 1) Use the UP or DOWN buttons to select SELF TEST.
- 2) Press and hold the MODE button to enter SELF TEST.



- 3) Use the UP or DOWN buttons to select YES.
- 4) Press and hold the MODE button to begin the SELF TEST.

During the SELF-TEST:

The MG3000 will run through a series of scripted self test programs designed to test the operation of the MG3000. The pointer will move through a series of angles and the buzzer will beep. When finished the LCD will display SELF TEST COMPLETE and then cycle through a normal start up self test. Once complete the display will return to the NORMAL mode.

**SELF TEST**  
SOFTWARE REV.  
PGFXXX\_XX

## Software Version

The Software feature is used to show the current version of software that is operating in the MG3000. This is particularly useful information when communicating with technical support.

To view the current Software version enter the SYSTEM menu (page 11) then:

- 1) Use the UP or DOWN buttons to select SOFTWARE.
- 2) Press and HOLD the MODE button to enter the selection.

The display will show

- the program identifier (starts with PGF followed by three numbers),
- the revision for the program identifier
- the release date for the software

**SYSTEM INFO**  
**SOFTWARE**  
INITIALIZE  
LANGUAGE

**SOFTWARE**  
PGFXXX  
REV: X##  
05/14/2012

## Performing A Master Reset

The Master Reset feature is used to reset the MG3000 to the factory default settings.

To perform a Master Reset, enter the SYSTEM menu (page 11) then:

- 1) Use the UP or DOWN buttons to select MASTER RESET.
- 2) Press and hold the MODE button to enter the selection.
- 3) When prompted to PERFORM MASTER RSET?. use the UP or DOWN buttons to select YES or NO.

If NO is selected the MG3000 will exit to the SYSTEM menu. If YES is selected continue with the next step.

A warning message will display for five seconds while beeping three times which is then replaced with "CONTINUE WITH RSET?".

- 4) Use the UP or DOWN buttons to select YES or NO.
- 5) Press and hold the MODE button to enter the selection.

If NO is selected, the MG3000 will exit to the SYSTEM menu.

If YES is selected, the MG3000 will be reset to factory default settings.

**SYSTEM INFO**  
**MASTER RESET**  
SOFTWARE  
INITIALIZE

**PERFORM**  
**MASTER RSET?**  
**NO**  
**YES**

**CAUTION! THIS**  
**WILL RESET TO**  
**FACTORY**  
**SETTINGS**

**CONTINUE WITH**  
**MASTER RSET?**  
**NO**  
**YES**

## Fuel Set Up

Fuel Set Up is used to define the characteristics associated with each tank in the system and the Totalizer Functions. Use the Fuel Set Up screens to add fuel, reset the fuel used, set the tank size, select the fuel sender, calibrate the fuel sender, set the low fuel warning and select the fuel remaining source for each tank. The Totalizer settings are used to reset Totalizer fuel data and to set the Totalizer low fuel warning.

To enter the FUEL SETUP menu:

- 1) From the NORMAL mode, press the MODE button once to enter the Options menu.
- 2) Use the UP or DOWN buttons to select EDIT MENU.
- 3) Press and hold the MODE button to enter the selection.
- 4) Use the UP or DOWN buttons to select FUEL SETUP.
- 5) Press and hold the MODE button to enter the selection.

**EDIT MENU**  
**FUEL SETUP**  
**MAX SPEED**  
**DISPLAY**

## Fuel Tank Setup

Use FUEL SETUP (page 17) to set fuel tank capacity, select fuel sender, calibrate fuel sender, set the low fuel warning, add fuel, reset fuel used, and select fuel remaining source for each fuel tank.

Follow the steps below for performing each of these tasks:

- 1) Use the UP or DOWN buttons to select the fuel tank you wish to make adjustment to.
- 2) Press and hold the MODE button to enter the selection.
- 3) Follow the steps in the next sections.

**FUEL SETUP**  
**T:1 FUEL1**  
**T:2 FUEL2**

## Setting The Fuel Level

Setting the Fuel Level in the MG3000 is performed in the PORT MG3000 if more than one MG3000 is in use. To set the fuel level to full enter the FUEL SETUP menu (page 17), then:

- 1) Use the UP or DOWN buttons to select SET FULL.
- 2) Press and hold the MODE button to set fuel tank to FULL.
- 3) At prompt, SET TANK FULL, use the UP or DOWN buttons to select YES, the fuel tank is full, or NO to return to the SET FUEL menu.
- 4) Use the MODE button to make the selection.

**T#: FUEL#**  
**SET FULL**  
**ADD FUEL**

**SET TANK FULL**  
**NO**  
**YES**

If YES was selected the LCD screen will display SETTING SAVED! and then return you to the SET FUEL menu.

## Adding Fuel to the Fuel Tank:

- 1) Use the UP or DOWN buttons to select ADD FUEL
- 2) Press and hold the MODE button to enter the TANK # ADD menu.

**T#: FUEL#**  
**ADD FUEL**  
**SET FULL**

- 3) Use the UP or DOWN buttons to set the volume of Fuel that has been added to the fuel tank.
- 4) Press and hold the MODE button to save the setting. The LCD screen displays SETTING SAVED! and the MG3000 issues an audible beep.

**Note:** Holding the UP or DOWN button will increase or decrease the amount in a more rapid fashion.

AMOUNT ADDED  
T#: FUEL#  
0.0 GAL  
PRESS ▲ OR ▼

## Setting The Tank Size

Enter the FUEL SETUP menu (page 17) then:

- 1) Use the UP or DOWN buttons to select TANK SIZE.
- 2) Press and hold the MODE button to enter the TANK SIZE menu.
- 3) Use the UP or DOWN buttons to set the capacity of the fuel tank.
- 4) Press and hold the MODE button to save the setting. The LCD screen displays SETTING SAVED! and the MG3000 issues an audible beep.

**Note:** Holding the UP or DOWN button will increase or decrease the amount in a more rapid fashion.

TANK 1  
TANK SIZE  
CAL SENDER  
SOURCE

SET FUEL  
T#: FUEL#  
0 GAL  
PRESS ▼ OR ▲

## Calibrating The Fuel Sender

Each Fuel Tank sender can be individually calibrated using the steps below. The Fuel Sender can be calibrated by a 2, 3 or 5-point calibration. To begin the calibration the fuel tank must be empty. It is recommended that a 5-point calibration be performed to achieve the best fuel level accuracy. To calibrate the sender enter the FUEL SETUP menu (page 17) then:

- 1) Use the UP or DOWN buttons to select CAL SENDER.
- 2) Press and hold the MODE button to enter the selection.
- 3) Use the UP or DOWN buttons to select the desired 2, 3, or 5 point calibration method.
- 4) Press and hold the MODE button to begin the calibration process.
- 5) Follow the on-screen prompts for each step of the calibration process. Be sure to press and hold the MODE button to save each calibration point. The LCD screen displays SETTING SAVED! and the MG3000 issues an audible beep.

CAL SENDER  
2 POINT  
3 POINT  
5 POINT

HOLD MODE  
FOR > 1 SEC  
WHEN TANK 1  
IS EMPTY

## Low Fuel Warning Level

The low warning alarm is used to let the user know when the tank has emptied below a set volume. To set the LOW WARN alarm enter the FUEL SETUP menu (page 17) select a tank then:

- 1) Use the UP or DOWN buttons to select LOW WARN.
- 2) Press and hold the MODE button to enter the selection.
- 3) Use the UP button to increase or the DOWN button decrease the low fuel warning level.
- 4) Press and hold the MODE button to save the setting. The LCD screen displays

T#: FUEL#  
LOW WARNING  
FUEL LEVEL  
TANK SIZE

LOW FUEL  
WARNING  
0.0 GAL  
PRESS ▲ OR ▼

SETTING SAVED! and the MG3000 issues an audible beep.

**Note:** Holding the UP or DOWN button will increase or decrease the amount in a more rapid fashion.

## Fuel Totalizer

The Fuel Totalizer is used when more than one Fuel Tank is installed in the system. The Totalizer will monitor all the installed Fuel Tanks, gather the data and combine for fuel usage data that represents the entire system. The MG3000 automatically collects the fuel data based on the settings in the individual tank settings completed in FUEL SETUP. If you have not completed the individual tank set up go to Fuel Set.

The Fuel Totalizer allows the user to select TFUEL USED, TFUEL LEFT, TFUEL INST TFUEL FLOW or TFUEL AVG in the default pages set up.

TFUEL USED - Total Fuel Used - Displays the total amount of fuel used since the last reset.

TFUEL LEFT - Total Fuel Left - Displays the total amount of fuel left since last reset.

TFUEL INST - Total Instantaneous Fuel Flow - Measures how much fuel is flowing at this time for all engines combined into one amount.

TFUEL AVG - Total Average Fuel Flow - Average of fuel flow from all engines taken over a period of time.

### To reset the Totalizer Fuel Used:

The only user selectable function in the Fuel Totalizer is the RESET TOTALIZER.

**Warning:** Resetting the totalizer will also reset all collected Fuel economy data.

To reset the Fuel Totalizer:

- 1) From the NORMAL mode, press and hold the MODE button.
- 2) Use the UP or DOWN buttons to select RESET TFUEL.
- 3) When prompted, TOTALIZER RESET? use the UP or DOWN buttons to select YES to reset the totalizer fuel used, or select NO to exit.
- 4) Press and hold the MODE button to save the setting. The LCD screen displays SETTING SAVED! and the MG3000 issues an audible beep.

HOLD MODE  
TO ENTER  
**RESET TOTALIZER**  
TRIP DATA

TOTALIZER  
RESET?  
**NO**  
YES



## Max Speed

The Max Speed function records the highest speed during the last period since reset. To view or reset the max speed enter the EDIT menu (page 11) then:

- 1) Use the UP or DOWN buttons to select MAX SPEED.
- 2) Press and hold the MODE button to enter the selection.
- 3) Follow the steps in the next sections.

EDIT MENU  
MAX SPEED  
DISPLAY  
DATA SOURCES

### View Max Speed

- 1) Use the UP or DOWN buttons to select VIEW.
- 2) Press and hold the MODE button to enter the selection.

MAX SPEED  
VIEW  
RESET

**Note:** The MAX SPEED is displayed on the MG3000 LCD display.

### Resetting Max Speed

- 1) Use the UP or DOWN buttons to select RESET.
- 2) Press and hold the MODE button to enter the selection.
- 3) Use the UP or DOWN buttons to select YES to reset the Max Speed or NO to exit.
- 4) Press and hold the MODE button to reset the data. The LCD screen displays SETTING SAVED! and the MG3000 issues an audible beep.

MAX SPEED  
57.4 MPH

MAX SPEED  
RESET  
VIEW

## Display Settings

The Display Settings control the data page's appearance and functionality. Use the display settings set the number of data pages shown, edit the data fields that are shown on each page, select the default data page, turn on or off the NORMAL mode auto scrolling feature and to set the display units.

To change the display settings:

- 1) From the NORMAL mode, press the MODE button once to enter the Options menu.
- 2) Use the UP and/or DOWN buttons to select the EDIT MENU.
- 3) Press and hold the MODE button to enter the selection.
- 4) Use the UP and/or DOWN buttons select DISPLAY.
- 5) Press and hold the MODE button to enter the selection.
- 6) Press and hold the MODE button to enter the selection.



### Setting the Number of Data Pages

There are fourteen (14) default data pages. Each data page can contain up to two data fields. To increase or decrease the number of data pages shown in NORMAL mode enter the DISPLAY menu (page 21) then:

- 1) Use the UP and/or DOWN buttons to select # OF SCREENS.
- 2) Press and hold the MODE button to enter the selection.
- 3) Use the UP button to increase or the DOWN button to decrease the number of data pages.



The minimum number of data pages is one (1) and the maximum is nine (22).

- 4) Hold the MODE button to save the selection. The LCD screen displays SETTING SAVED! and the MG3000 issues an audible beep.

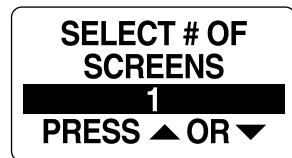

### Screen Setup

Use the Screen Setup to select the data fields that are shown on each page in Normal Mode. See **DEFAULT PAGES AND DISPLAY SETTINGS** on page 6. To edit the data fields displayed, enter the DISPLAY menu (page 21) then:

- 1) Use the UP and/or DOWN buttons to select SCREEN SETUP.
- 2) Press and hold the MODE button to enter the selection.
- 3) Use the UP or DOWN buttons to select the page number to edit the data fields.
- 4) Hold the MODE button to enter the page to edit.
- 5) Use the UP or DOWN buttons to select the data field to display on line one.
- 6) Press and hold the MODE button to save the selection. The LCD screen displays SETTING SAVED! and the MG3000 issues an audible beep.

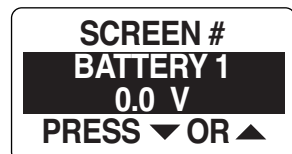
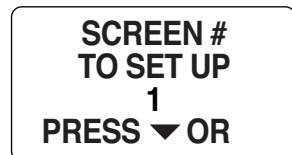
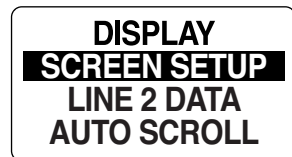

## Setting the Line 2 Data

The MG3000 can show limited data on the second line of the LCD display. To select the Line 2 data enter the DISPLAY menu (page 21) then:

- 1) Use the UP and/or DOWN buttons to select LINE 2 DATA.
- 2) Press and hold the MODE button to enter the selection.
- 3) Use the UP or DOWN button to select the data you wish to see in the line 2 display.

**Note:** The choices for the Line 2 Data can be selected from Fuel Level, Water Level and OFF. (Some units may have options for Oil Level, Ballast, Baitwell, Fresh Water, Gray Water and Black Water.)

- 4) Hold the MODE button to save the selection. The LCD screen displays SETTING SAVED! and the MG3000 issues an audible beep.

DISPLAY  
**LINE 2 DATA**  
 AUTO SCROLL  
 LCD COLOR

LINE 2 DATA  
**FUEL LEVEL**  
 WATER LEVEL  
 OFF

## Data Page Auto Scroll Setting

The AUTO SCROLL feature, when active, automatically scrolls through the data pages at a user-defined interval. To set up and activate the auto scroll feature enter the DISPLAY menu (page 21) then:

- 1) Use the UP and/or DOWN buttons to select AUTO SCROLL.
- 2) Press and hold the MODE button to enter the selection.
- 3) Use the UP or DOWN button to select STATUS.
- 4) Hold the MODE button to enter the selection.
- 5) Use the UP or DOWN buttons to select ON or OFF.
- 6) Press and hold the MODE button to save the status selection. The LCD screen displays SETTING SAVED! and the MG3000 issues an audible beep.

DISPLAY  
**AUTO SCROLL**  
 LCD COLOR  
 # OF SCREENS

AUTOSCROLL  
**STATUS**  
 TIME

SELECT AUTO  
 SCROLL STATUS  
**ON**  
 OFF

### To change the Auto Scroll interval Time:

- 1) Use the UP or DOWN buttons to select TIME.
- 2) Press and hold the MODE button to enter the selection.
- 3) Use the UP button to increase or the DOWN button to decrease the interval.
- 4) Press and hold the MODE button to enter the selection.

AUTOSCROLL  
**TIME**  
 STATUS

The minimum Auto Scroll interval is one (1) second, the maximum interval is sixty (60) seconds.

- 5) Press and hold the MODE button to save the interval setting. The LCD screen displays SETTING SAVED! and the MG3000 issues an audible beep.

AUTO SCROLL  
 TIME INTERVAL  
 30 SEC  
 PRESS ▲ OR ▼

### LCD Color (Not available with all MG3000 packages)

The MG3000 gauge package has the ability to change the color of the LCD back light. To change the color of the LCD back lighting enter the DISPLAY menu (page 21) and then:

- 1) Use the UP or DOWN buttons to select LCD COLOR.
- 2) Press and hold the MODE button to enter the selection.
- 3) Use the UP or DOWN buttons to select the desired color.

**Note:** The color choices are WHITE, YELLOW, GREEN YELLOW, GREEN, DARK SEA GREEN, CYAN, BLUE, PURPLE, PINK, GOLDENROD or TAN.

- 4) Press and hold the MODE button to save selection.



## Data Sources

Use DATA SOURCES to set the engine instance and to set or reset the maintenance interval for the engine. Use the data source menu to set the instance ID for the 2" gauges connected to the MG3000 for Battery and Oil Level gauges.

The MG3000 is capable of using up to five analog senders for Fuel, Trim, Ballast, Bait Well, Rudder, Fresh Water, Gray Water or Black Water.

Refer to your manufacturers Gauge Installation Guide of installation instructions for input values. To enter the DATA SOURCES menu:

- 1) From the NORMAL mode, press the MODE button once.
- 2) Use the UP and/or DOWN buttons to select EDIT MENU.
- 3) Press and hold the MODE button to enter the selection.
- 4) Use the UP or DOWN buttons to select DATA SOURCES .
- 5) Press and hold the MODE button to enter the selection.

**EDIT MENU**  
**DATA SOURCES**  
 CSTM ALARMS  
 POP UP ALERTS

## Tanks

The Tanks data source is where the source of the information that is received from a particular tank will display. The MG3000 can display information from an analog (US 240-33, EU 10-180 Fuel Senders), or digital sources (Bus Data). To make changes to the tank's data source enter the DATA SOURCES menu (page 24) then:

- 1) Use the UP and/or DOWN buttons to select TANKS.
- 2) Press and hold the MODE button to enter the selection.
- 3) Use the UP or DOWN buttons to select the TANK # to make changes to.
- 4) Press and hold the MODE button to enter the selection.
- 5) Use the UP or DOWN buttons to select TANK SOURCE.
- 6) Press and hold the MODE button to save the new selection. The LCD screen displays SETTING SAVED! and the MG3000 issues an audible beep.

**Note:** If an Analog source is picked you will be prompted to choose which pin the analog signal is attached to the MG3000 harness. Select the connector pin which the analog input is attached. See the Wiring Diagram on page 2 for available pin points.

- 7) Repeat for all tanks.

**DATA SOURCES**  
**TANKS**  
 ENGINE

**TANK SOURCE**  
 T1: XXXXX  
 T2: XXXXX  
 T1: XXXX2

**TANK 1 SOURCE**  
**US 240-33**  
 EU 10-180  
 BUS DATA - 0

**ANALOG**  
**#1 P1 - 6**  
**#2 P1 - 7**  
**#3 P1 - 8**

## Engine

Note: Some manufacturers may have already set this value for you, if so skip this step.

The Engine Data Source was set during initialization. If there is a need to change the Engine ID enter the DATA SOURCES menu (page 24) then:

- 1) Use the UP and/or DOWN buttons to select ENGINE.
- 2) Press and hold the MODE button to enter the selection.
- 3) Use the UP or DOWN buttons to select ENGINE ID .

**DATA SOURCES**  
**ENGINE**  
 TANKS

- 4) Press and hold the MODE button to enter the selection.
- 5) Use the UP or DOWN buttons to select Engine ID.

**Note:** You can set the engine ID to PORT, MID PORT, MID STARBOARD and STARBOARD. If there is only one engine the engine ID is SINGLE.

- 6) Press and hold the MODE button to save the new ENGINE ID. The LCD screen displays SETTING SAVED! and the MG3000 issues an audible beep.



### Engine Maintenance Interval

The MG3000 monitors the engine hours and notify the operator when maintenance is needed. To set the MAINTENANCE INTERVAL enter the DATA SOURCES menu (page 24) then:

- 1) Use the UP and/or DOWN buttons to select ENGINE.
- 2) Press and hold the MODE button to enter the selection.
- 3) Use the UP or DOWN buttons to select MAINT INTRVL.
- 4) Press and hold the MODE button to enter the selection.
- 5) Use the UP button to increase, or the DOWN button to decrease the Maintenance Interval.

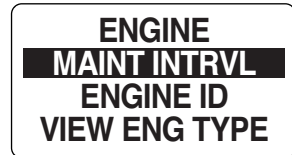

**Note:** A POP UP window will open when the Maintenance Interval is reached.

- 6) Press and hold the MODE button to save the setting. The LCD screen displays SETTING SAVED! and the MG3000 issues an audible beep.

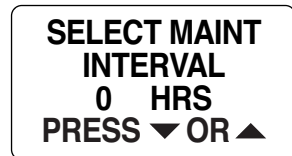

### Reset the Maintenance Interval:

- 1) Use the UP and/or DOWN buttons to select ENGINE.
- 3) Press and hold the MODE button to enter the selection.
- 4) Use the UP or DOWN buttons to select RESET INTRVL.
- 5) Press and hold the MODE button.



At the prompt: RESET MAINT INTERVAL YES/NO

- 6) Use the UP or DOWN buttons to select YES to reset the maintenance interval, or select NO to exit. The LCD screen displays SETTING SAVED! and the MG3000 issues an audible beep.

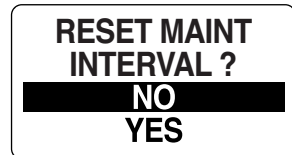

### Set Engine Manufacturer Type

Note: Some manufacturers may have already set this value for you, if so skip this step.

To view the engine type enter the DATA SOURCES menu (page 24) then:

- 1) Use the UP and/or DOWN buttons to select ENGINE.
- 2) Press and hold the MODE button to enter the selection.
- 3) Use the UP or DOWN buttons to select TYPE.
- 4) Press and hold the MODE button to enter the selection.

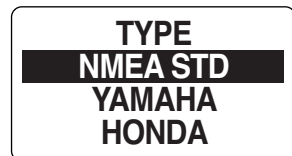
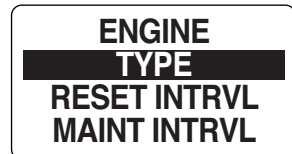

- 5) Use the UP or DOWN buttons to select engine type; NMEA STD, YAMAHA, HONDA, CUMMINS.
- 6) Press and hold the MODE button to save the selection.

## Set Engine ID

Note: Some manufacturers may have already set this value for you, if so skip this step.

The engine can be identified as either: PORT, MID PORT, MID STARBOARD and STARBOARD,. If only one engine is identified the MG3000 will automatically select the engine identifier SINGLE and save. To change the Engine ID setting, enter the DATA SOURCES menu (page 24) then:

- 1) Use the UP and/or DOWN buttons to select ENGINE.
- 2) Press and hold the MODE button to enter the selection.
- 3) Use the UP or DOWN buttons to select ENGINE ID.
- 4) Press and hold the MODE button to enter the selection.
- 5) Use the UP or DOWN buttons to select the proper engine ID based on the location of the engine.
- 4) Press and hold the MODE button to save the setting. The LCD screen displays SETTING SAVED! and the MG3000 issues an audible beep.

**SET ENGINE ID**  
**PORT**  
 MID PORT  
 STARBOARD

## Trim (Not available with all MG3000 packages)

The MG3000 can monitor multiple trim senders. By default the trim sender is set to NMEA 2000. To change the trim sender setting, enter the DATA SOURCES menu (page 24) then:

- 1) Use the UP and/or DOWN buttons to select TRIM.
- 3) Press and hold the MODE button to enter the selection.
- 4) Use the UP or DOWN buttons to select SELECT SENDER.
- 5) Press and hold the MODE button to enter the selection.
- 6) Use the UP or DOWN buttons to select the desired trim sender.
- 7) Press and hold the MODE button to save the selection. The LCD screen displays SETTING SAVED! and the MG3000 issues an audible beep.

**TRIM**  
**SELECT SENDER**  
 CAL SENDER

**SELECT SNDR**  
**NMEA 2000**  
 EVINRUDE  
 MERCURY

**TRIM**  
**CAL SENDER**  
 SELECT SENDER

## Calibrating Trim Sender (Not available with all MG3000 packages)

Use the MG3000 to calibrate the trim sender. To calibrate the trim sender, enter the DATA SOURCES menu (page 24) then:

- 1) Use the UP and/or DOWN buttons to select TRIM.
- 2) Press and hold the MODE button to enter the selection.
- 3) Use the UP or DOWN buttons to select CAL SENDER.
- 4) Press and hold the MODE button to enter calibration.

**HOLD MODE**  
**FOR > 1 SEC**  
**WHEN TRIM IS**  
**FULL DOWN**

**HOLD MODE**  
**FOR > 1 SEC**  
**WHEN TRIM IS**  
**FULL UP**

- 5) The LCD screen displays: HOLD MODE FOR > 1 SEC WHEN TRIM FULL DOWN.
- 6) Make sure the engine is in the full trim DOWN position. Then press and hold the MODE button to save the trim DOWN position. The LCD screen displays SETTING SAVED! and the MG3000 issues an audible beep.
- 7) The LCD screen displays: HOLD MODE FOR >1 SEC WHEN TRIM FULL UP.
- 8) Make sure the engine is in the full trim UP position. Then press and hold the MODE button to save the trim UP position. The LCD screen displays SETTING SAVED! and the MG3000 issues an audible beep.
- 9) The Trim Sender is now calibrated.

### Battery (Not available with all MG3000 packages)

Use the Battery Data Source to determine the number of the batteries that are installed in the system. By default the battery instance matches the engine ID. The number of batteries is set to the number of engines selected during initialization. To change the battery settings enter the DATA SOURCES menu (page 24) then:

- 1) Use the UP and/or DOWN buttons to select BATTERY.
- 2) Press and hold the MODE button to enter the selection.
- 3) Use the UP or DOWN buttons to select the number of batteries.
- 4) Press and hold the MODE button to save the selection. The LCD screen displays SETTING SAVED! and the MG3000 issues an audible beep.

**SELECT BATTERY  
NUMBER**  
1  
**PRESS ▼ OR**

### Oil Pressure (Not available with all MG3000 packages)

Use the Oil Level Data Source to determine the source of the oil pressure used in the system.. To change oil pressure sender data source enter the DATA SOURCES menu (page 24) then:

- 1) Use the UP and/or DOWN buttons to select OIL PRESSURE.
- 2) Press and hold the MODE button to enter the selection.
- 3) Use the UP or DOWN buttons to select the OIL PRESSURE sender type which is used in the system.
- 4) Press and hold the MODE button to enter the selection. The LCD screen displays SETTING SAVED! and the MG3000 issues an audible beep.

**OIL PRESSURE  
ANALOG  
BUS DATA**

**Note:** If an Analog source is picked you will be prompted to choose which pin the analog signal is attached to the MG3000. Select the connector pin which the analog input is attached. See the Wiring Diagram on page 2 for available pin points.

### Water Temp (Not available with all MG3000 packages)

Use the Water Temp Data Source to determine the source of the Water temperature used in the system. To change water temperature sender data source enter the DATA SOURCES menu (page 24) then:

- 1) Use the UP and/or DOWN buttons to select WATER TEMP.
- 2) Press and hold the MODE button to enter the selection.

**ANALOG**  
#1 P1 - 6  
#2 P1 - 7  
#3 P1 - 8

**WATER TEMP  
ANALOG  
BUS DATA**

**ANALOG**  
#1 P1 - 6  
#2 P1 - 7  
#3 P1 - 8



- 3) Use the UP or DOWN buttons to select the WATER TEMP sender type which is used in the system.
- 4) Press and hold the MODE button to enter the selection. The LCD screen displays SETTING SAVED! and the MG3000 issues an audible beep.

**Note:** If an Analog source is picked you will be prompted to choose which pin the analog signal is attached to the MG3000. Select the connector pin which the analog input is attached. See the Wiring Diagram on page 2 for available pin points.

**AIR TEMP**  
**ANALOG**  
**BUS DATA**

### **Air Temp** (Not available with all MG3000 packages)

Use the Air Temp Data Source to determine the source of the air temperature used in the system. To change air temperature sender data source enter the DATA SOURCES menu (page 24) then:

- 1) Use the UP and/or DOWN buttons to select AIR TEMP.
- 2) Press and hold the MODE button to enter the selection.
- 3) Use the UP or DOWN buttons to select the AIR TEMP sender type which is used in the system.
- 4) Press and hold the MODE button to enter the selection. The LCD screen displays SETTING SAVED! and the MG3000 issues an audible beep.

**Note:** If an Analog source is picked you will be prompted to choose which pin the analog signal is attached to the MG3000. Select the connector pin which the analog input is attached. See the Wiring Diagram on page 2 for available pin points.

**ANALOG**  
**#1 P1 - 6**  
**#2 P1 - 7**  
**#3 P1 - 8**

### **Speed** (Not available with all MG3000 packages)

The MG3000 can accept speed information from many sources, including Paddle Wheel, Pitot, Bus Data and GPS. To change the Speed source setting, enter the DATA SOURCES menu (page 24) then:

- 1) Use the UP and/or DOWN buttons to select SPEED SOURCE.
- 2) Press and hold the MODE button to enter the selection.
- 3) Use the UP or DOWN buttons to select speed source used by the system.
- 4) Press and hold the MODE button to save the selection. The LCD screen displays SETTING SAVED! and the MG3000 issues an audible beep.

**SPEED SOURCE**  
**PADDLE WHEEL**  
**PITOT**  
**GPS**

### **Steering Angle** (Not available with all MG3000 packages)

To change the steering angle setting, enter the DATA SOURCES menu (page 24) then:

- 1) Use the UP and/or DOWN buttons to select STEERING ANGLE.
- 2) Press and hold the MODE button to enter the selection.
- 3) Use the UP or DOWN buttons to select how the steering angle is used in the system.
- 4) Press and hold the MODE button to save the selection. The LCD screen displays SETTING SAVED! and the MG3000 issues an audible beep.

**STEERING ANGLE**  
**NORMAL**  
**INVERTED**

## Pop Up Alerts

The Pop Up feature alerts users when a change occurs in a monitored data field. The MG3000 has Pop Up alerts available for RPM, TRIM CHANGE, FUEL ECONOMY, DURATION, EST RANGE and SPEED.

By default all Pop Up messages set to OFF. To turn ON pop ups and set the threshold for data fields:

- 1) From the NORMAL mode, press the MODE button once.
- 2) Use the UP or DOWN buttons to select the EDIT MENU.
- 3) Press and hold the MODE button to enter the selection.
- 4) Use the UP or DOWN buttons to select POP UP ALERTS.
- 5) Press and hold the MODE button to enter the selection.

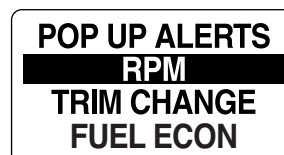
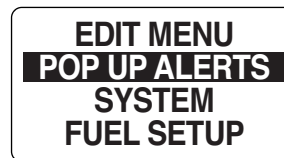

### To turn a POP UP alert ON or OFF

- 1) Use the UP or DOWN buttons to select the POP UP alert you wish to use.
- 2) Press and hold the MODE button to make the selection.
- 3) Use the UP or DOWN buttons to select STATUS.
- 4) Press and hold the MODE button to enter the selection.
- 5) Use the UP or DOWN button to select ON or OFF.
- 6) Press and hold the MODE button to save the selection.

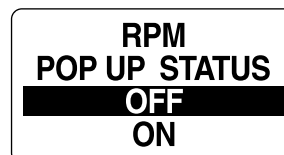
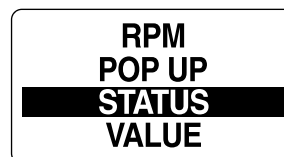

### To set the POP UP threshold value:

The POP UP threshold value is the value that will trigger a POP UP alert to activate.

- 1) Use the UP or DOWN button to select VALUE.
- 2) Press and hold the MODE button to enter the selection.
- 3) Use the UP or DOWN buttons to set the desired value to activate the pop-up.
- 4) Press and hold the MODE button to save the setting. The LCD screen displays SETTING SAVED!.

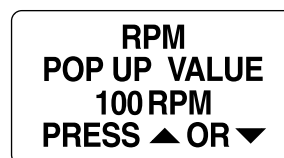
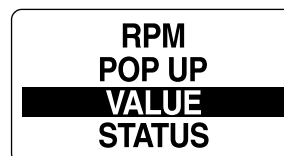

### Setting the Pop Up Duration

The Pop Up Duration setting defines the amount of time a Pop Up screen remains active before returning to current the NORMAL mode Data Page. Follow the steps below to edit the Pop Up Alerts Duration:

- 1) Use the UP or DOWN buttons to select DURATION.
- 2) Press and hold the MODE button to enter the selection.
- 3) Press the UP button to increase or the press the DOWN button to decrease the pop up duration.
- 4) Press and hold the MODE button to save the setting. The LCD screen displays

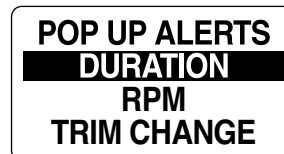

SETTING SAVED! and the MG3000 issues an audible beep.

## Setting Custom Alarms

A Custom Alarm can be set for select data fields present in the MG3000. To set a custom pop up,

- 1) From the NORMAL mode, press and hold the MODE button to enter the Menu Options.
- 2) Use the UP or DOWN buttons to select CSTM ALARMS.
- 3) Press and hold the MODE button to make selection.
- 4) Use the UP or DOWN buttons to select the desired data field.

Available data fields are OIL PRESSURE and ENGINE TEMPERATURE.

- 5) Press and hold the MODE button to save selection. Continue with the steps below.

### To turn a Custom Alarm alert ON or OFF

- 1) Use the UP or DOWN buttons to select STATUS.
- 2) Press and hold the MODE button to enter the selection.
- 3) Use the UP or DOWN button to select ON or OFF.
- 4) Press and hold the MODE button to save the selection.

### To set the Custom Alarm threshold value:

The CUSTOM ALARMS threshold value is the value that will trigger a CUSTOM ALARM alert to activate.

- 1) Use the UP or DOWN button to select VALUE.
- 2) Press and hold the MODE button to enter the selection.
- 3) Use the UP or DOWN buttons to set the desired value to activate the pop-up.
- 4) Press and hold the MODE button to save the setting.

POP UP ALERTS  
CSTM ALARMS  
POP UP ALERTS  
SYSTEM

CSTM ALARMS  
OIL PRESSURE  
TEMPERATURE

CSTM ALARMS  
OIL PRESSURE  
STATUS  
VALUE

CSTM ALARMS  
OIL PRES STAT  
ON  
OFF

CSTM ALARMS  
OIL PRESSURE  
VALUE  
STATUS

SET ALARM  
OIL PRES VALUE  
80 PSI  
PRESS ▼ OR ▲

## Troubleshooting

Use a process of elimination to troubleshoot network problems.

1. If the MG3000 digital gauge package is displaying values of “---” for data fields it indicates the gauge is not receiving the data signal from one or more devices.
  - Make sure data sources are configured.
  - If multiple data fields are displaying “0”, check common items such as cables and t-connectors.
  - Remove components from the network one at a time to isolate the failing component.
  - Look for damaged parts. Check connectors for corrosion.
  - Swap known good components (sensor, cables or tees) to isolate the faulty component.
  - Reconnect the good components to the network and remove the next one in line.
  - Continue the process for each device, cable or tee connector on the network until the faulty part is found.

**Note:** Once components are reconnected, if the digital display continues to show “0”, turn the power to the network OFF and back ON to reset the gauge(s).

## Engine Warnings

The MG3000 monitors engine conditions and displays warnings in the event of a malfunction. Refer to the outboard *Operator's Guide* if any engine warnings are displayed.

Engine Warning	Type of Error	Possible Cause	Procedure
Engine TPS Fault	Critical	A throttle position sensor fault has been detected.	Seek assistance to return to a safe harbor immediately and see your dealer.
Engine Oil Pressure Low	Critical	Engine Oil Pressure is LOW	
Engine Temperature High	Critical	Engine Coolant Temperature is HIGH	
Transmission Service Required	Critical	Transmission Oil Pressure is LOW	
	Critical	Transmission Oil Temperature is HIGH	
	Critical	Transmission Oil Level is LOW	
Engine Emergency Stop	Critical	Engine Emergency Stop Mode.	Slow the engine down.
Engine Rev Limit Exceeded	Critical	Engine Speed limit exceeded	See your dealer as soon as practical.
Check Engine Service Required	Critical	A “Check Engine” condition is activated when a critical engine condition occurs, or when a service is required.	
<b>Warning</b>			
Water in Fuel	Warning	Water in Fuel	See your dealer.
Engine Oil Level LOW	Warning	Engine Oil level is below normal.	See your dealer.
Engine Boost Press HIGH	Warning	Engine Boost Pressure is High.	See your dealer.
Engine Coolnt Temp LOW	Warning	Engine Coolant Temperature is below normal.	See your dealer.
System Charge Indicator	Warning	Engine Charging Potential is below normal.	See your dealer.
Battery Voltage LOW	Warning	Battery Potential is below normal.	See your dealer.
Engine Maintenance Required	Warning	Maintenance is required.	See your dealer.
<b>Other Engine Warnings</b>			
Engine Voltage HIGH	Warning	Battery Potential is higher than normal.	See your dealer.
Engine Fuel Press LOW	Warning	Low Fuel Pressure	See your dealer.
Warning Level 1	Warning		See your dealer.
Warning Level 2	Warning		See your dealer.

Engine Warning	Type of Error	Possible Cause	Procedure
Water Flow Low	Warning	Water Flow is below normal.	See your dealer.

## Network Troubleshooting Chart

Observation	Possible Cause	Procedure
"0" displayed for data fields	Data sources are not configured	Use DATA SOURCES menu to configure data source.
MG3000 does not power on.	Power supply harness fuse blown.	Check the Power Supply harness, fuses and switched B+ from the ignition harness. See <b>Note</b> below.
Power Supply harness blown fuse	Network current draw is exceeding 3A.	Check all connections and wiring. Disconnect accessory connections to network. Isolate possible overloads or shorted accessory.
No Speed display.	Requires input from NMEA 2000 Speed transducer or paddle wheel.	Check that the device is installed and connected to the network.
Speed Over Water (SOW) does not display.		
Speed Over Ground (SOG) does not display.		
Water depth does not display.		
Sea water temperature does not display.		
Fuel tank level does not display.		
	Requires NMEA 2000 depth transducer.	
	Requires NMEA 2000 temperature transducer or analog sender.	
	Requires fuel level sensor or analog sender.	

**Note:** The MG3000 harness must be connected to the NMEA 2000 network using the device port of a t-connector. Misaligned t-connectors can cause the NMEA 2000 network power supply fuse to blow and disrupt or eliminate communications in the system.

Observation	Possible Cause	Procedure
Oil tank level does not display.	Requires input from oil tank sender.	Each oil tank uses an outboard position-specific converter.
Engine water pressure does not display.	Requires input from a water pressure transducer.	Use diagnostics equipment to set the water pressure sensor setting.
Water pressure faults after initial setup.	Water pump is faulty.	Verify the operation of the water pump.
	The block-mounted water pressure sensor is not connected to the engine EMM.	Check the connection for the block-mounted water pressure sensor at the engine EMM.
	The NMEA 2000 network water pressure sensor is not configured properly.	Replace the NMEA 2000 water pressure with a known good component.
	Engine EMM is not correctly configured for the water pressure sensor.	Use diagnostics equipment to verify the water pressure sensor setting.
Instrument display is erratic.	Power supply battery voltage is less than 11.5V.	Check for a minimum 11.5 V across the terminals of the power supply battery.
	One or more terminators are missing from the NMEA 2000 network.	Check for installation of two terminators on the NMEA 2000 network. Check network bus cable and device connections.
Gauge repeatedly reset to factory defaults.	If this occurs during heavy power use possible poor battery condition exists.	Check system supply battery voltage with engine running. Check ignition and ground connections on pins 4 and 5 of the MG3000.

## Abbreviations Used

Abbreviation	Function
RPM	Engine Speed, Revolutions per minute.
OIL PRESS	Oil Pressure
OIL TEMP	Oil Temperature
COOLANT	Coolant Temperature
PORT TEMP	Engine Temperature
PORT HOURS	Engine Hours
TRANS GEAR	Gear Position
TRANS PRESS	Transmission Oil Pressure
THROTTLE	Throttle Percentage
ENGINE LOAD	Engine Load
FUEL TANK #	Fuel Tank 1-5
FUEL USED	Fuel Used
FUEL LEFT	Fuel Remaining
FUEL INST	Instantaneous Fuel Flow
FUEL FLOW	Average Fuel Flow
OIL LEVEL	Oil Level 1-5
BAITWELL	Bait Well
BLACK WATER	Black Water
GRAY WATER	Gray Water
RUDDER	Rudder Angle
BAROMETER	Barometric Pressure
TRIP A HOURS	Trip A Engine Hours
BATTERY #	Battery Identification
BOOST	Engine Boost
ODOMETER	Odometer
BTN	Button
CAL	Calibrate
CLR	Clear
CRRNT	Current
CUSTM ALRMS	Custom Alarms
DEG	Degree
DEPDNT	Dependent
DFLT	Default
DIAG MODE	Diagnostic Mode
ECON	Economy
ENGINE ID	Engine Identification
EST	Estimated
EURO	European
GMT	Greenwich Mean Time
GPS	Global Positioning System
INDPDNT	Independent
INSTRMENT	Instrument

Abbreviation	Function
TFULE USED	Total Fuel Used
TFUEL LEFT	Total Fuel Remaining
TFUEL INST	Total Instantaneous Fuel Flow
TFUEL AVG	Total Average Fuel Flow
FUEL ECON	Fuel Economy
LAT/LONG	Latitude/Longitude
GPS SPEED	GPS Speed
COG	Course Over Ground
CLOCK	Clock
HEADING	Heading
BATTERY #	Battery 1-5
TRIM	Trim
DEPTH	Depth
WATER PRESS	Water Pressure
BALLAST #	Ballast Tank 1-5
TRIP A	Trip A Fuel Used
TRIP A ODO	Trip A Odometer
TRIP A FAVG	Trip A Average Fuel Flow
SEASN HOURS	Season Engine Hours
SEASN FUEL	Season Fuel Used
SEASON ODO	Season Odometer
SEASN FAVG	Season Average Fuel Flow
FRESH WATER	Fresh Water Tank
EST RANGE	Estimated Range
INTRVL	Interval
LVL	Level
MAINT INTRV	Maintenance Interval
MID PORT	Middle Port Engine
MID STRBD	Middle Starboard Engine
MSTR	Master
PRESS	Pressure
RSET	Reset
REMAIN SRC	Remaining Source
SCRNS	Screens
SET	Setting
SPEEDO	Speedometer
SRCS	Sources
TEMP	Temperature
WARN	Warning
W/O	With Out
#	Number

## List of Supported PGNS

The Faria MG3000 uses PGN variables from the different engine manufacturers to provide the data reported in the MG3000 digital gauge system. Each engine manufacturer used their own recipe for their engine communications. For a list of the PGN data used please contact Faria Marine Instruments at 860.848.9271 eastern standard time between 8:30 a.m. and 5:00 p.m. A customer service person will be able to help determine the PGN data you are looking for.

## Warning Buzzer

The MG3000 has internal buzzers that are used for warnings as well as other audio settings that are controllable via the instrument's EDIT MENU (page 11).

## NORMAL MODE

TO EDIT MODE

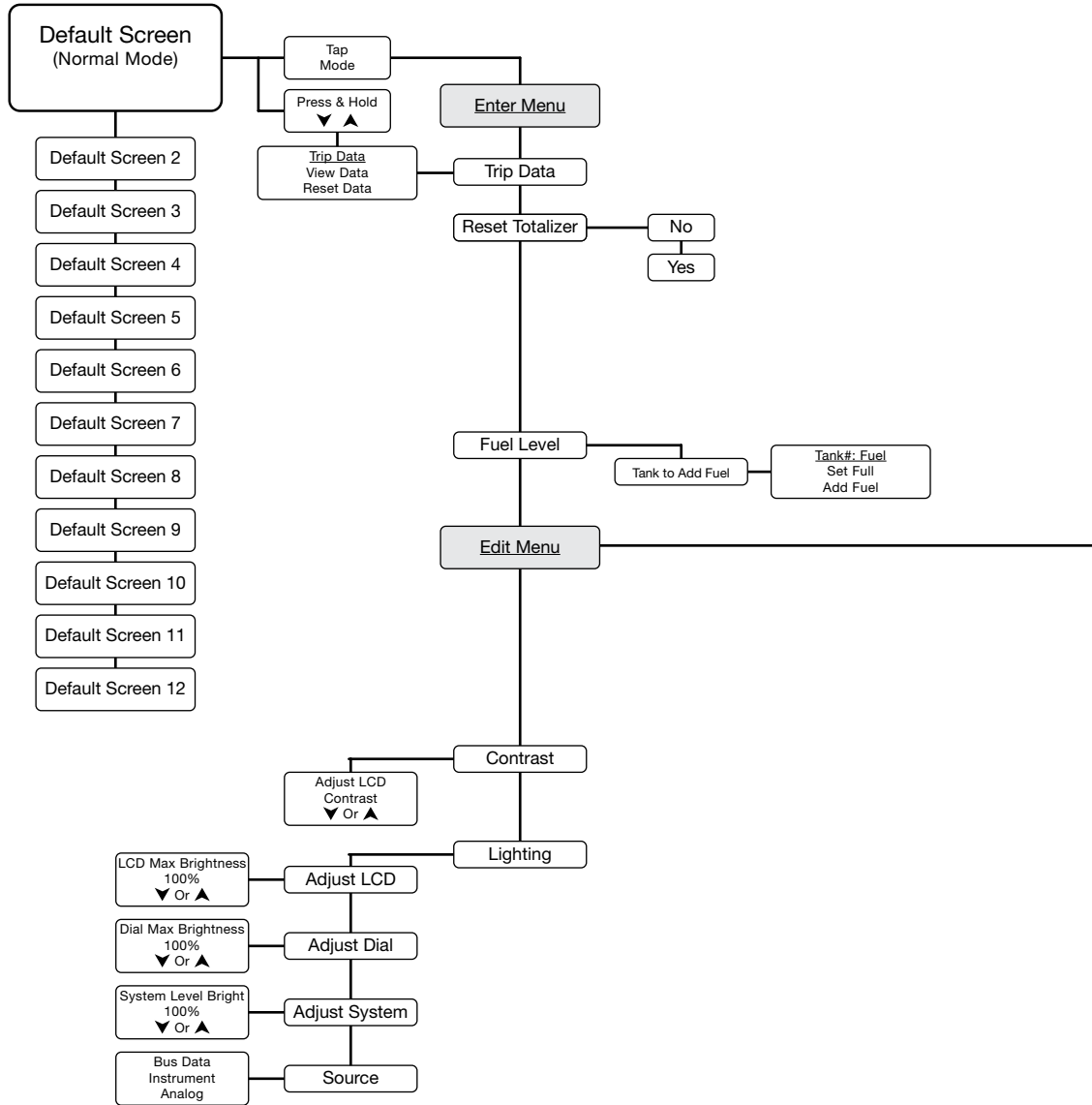

(Some function are not available with all MG3000 packages)



FROM NORMAL MODE

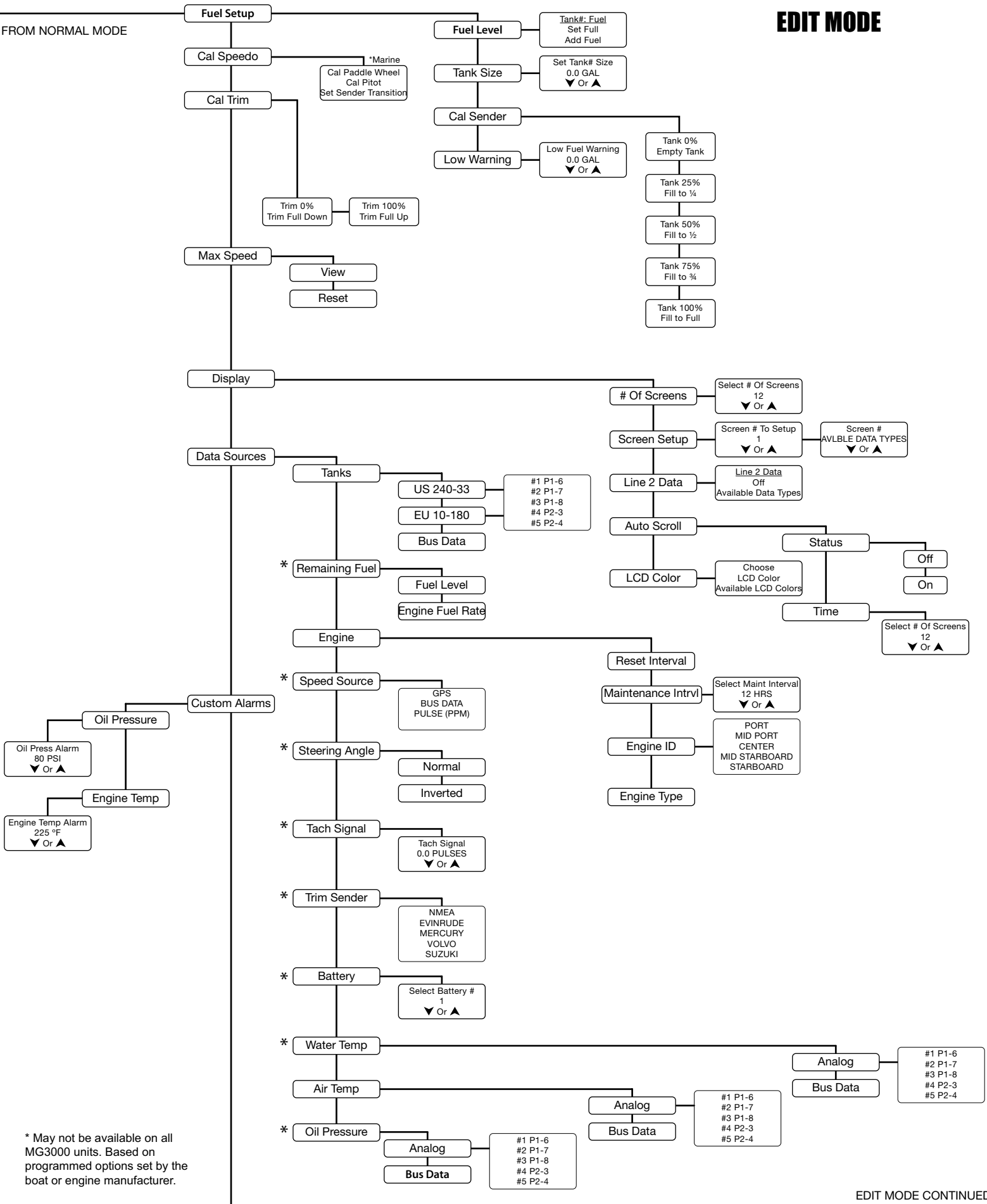

EDIT MODE CONTINUED

EDIT MODE CONTINUED

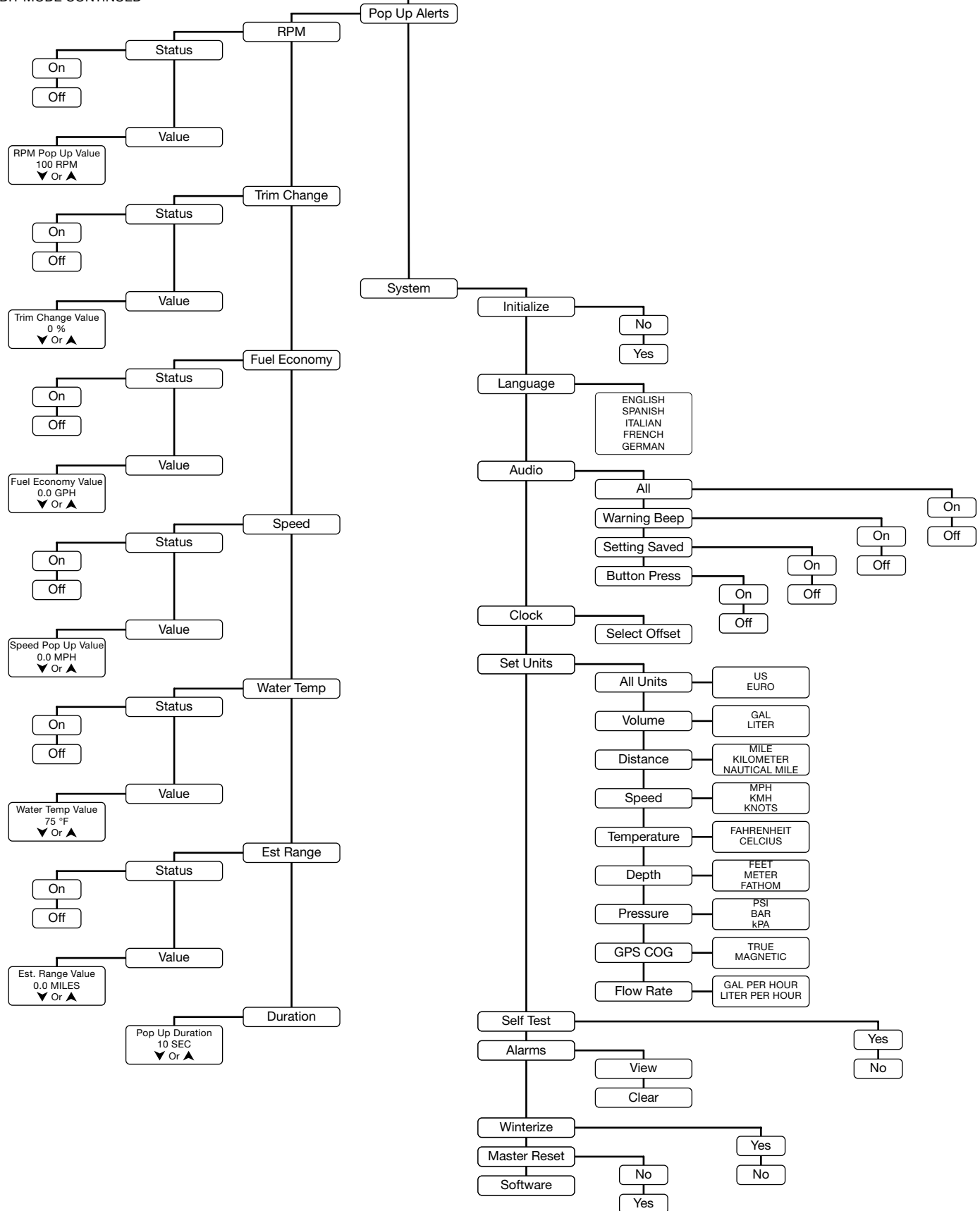

CONTINUED FROM LAST PAGE.



Thomas G. Faria Corporation  
P.O. Box 983 - 385 Norwich-New London Turnpike  
Uncasville, CT 06382, USA  
860.848.9271